



ARROW



ARROW II

Universal shoulder prosthesis

SURGICAL TECHNIQUE

ANATOMICAL

GROUP
FH ORTHO™

TABLE OF CONTENTS

1. Arrow II implant range	4
1.1. Range description	4
1.2. Indications for use	4
1.3. Use	4
1.4. Arrow II implants list	5
2. Deltopectoral incision	6
3. Humeral preparation	7
3.1. Use of the cutting guide	8
3.2. Choice of the humeral head	9
4. Glenoid preparation	10
4.1. Guide pin positioning	10
4.2. Glenoid bone preparation	11
5. Cemented glenoid	12
5.1. Bone preparation	12
5.2. Prosthesis trial reduction	13
5.3. Definitive implants	13
6. Cementless glenoid	13
6.1. Bone preparation	13
6.2. Metal-back glenoid base plate trial	14
6.3. Definitive implants	14
6.4. Glenoid insert impaction	16
7. Humeral definitive implants	17
7.1. Humeral stem	17
7.2. Humeral head	17
8. Instrumentation	18
8.1. Universal humerus	18
8.2. Universal glenoid	19
8.3. Universal anatomical	20
8.4. Option universal revision	21

1. Arrow II implant range

1.1. Range description



The Arrow II anatomical prosthesis is available in the following configurations:

- Simple humeral prosthesis (SHA): humeral stems and eccentric humeral heads,
- Anatomical total prosthesis (cemented glenoid implant with 4 pegs) (TSA cemented): humeral stems, eccentric humeral heads and cemented glenoids,
- Anatomical total prosthesis (metal-back glenoid implant) (TSA cementless): humeral stems, humeral heads, glenoid insert, and metal-back glenoid bases.

The instruments allow Total Shoulder Arthroplasty with consideration given to:

- Surgical approach: deltopectoral incision or superior-lateral incision,
- Prosthesis type: SHA, TCA cemented, TCA cementless.

1.2. Indications for use

Simple humeral prosthesis

- Dislocation fracture or complex fracture of the proximal end of the humerus,
- Osteonecrosis of the humeral head without glenoid lesions,
- Extensive cartilaginous lesions of the humeral head without glenoid lesions,
- Centered osteoarthritis with a glenoid that does not allow for implantation of a glenoid implant,
- Osteoarthritis with a ruptured cuff, but retaining an active elevation of at least 120°,
- Post-traumatic sequela with a glenoid lesion.

Anatomical total prosthesis (glenoid implant anchored with 4 pegs)

- Centered glenohumeral osteoarthritis,
- Rheumatoid arthritis,
- Post-traumatic sequela with a glenoid lesion.

A functional rotator cuff is needed to use this device.

Anatomical total prosthesis (metal-back glenoid implant)

- Centered glenohumeral osteoarthritis,
- Post-traumatic sequela with a glenoid lesion,
- Revision for glenoid loosening,
- Loss of glenoid bone substance requiring reconstruction with a graft.

A functional rotator cuff is needed to use this device.

1.3. Use

All shoulder prosthesis implants are intended to be used for primary shoulder arthroplasty or for revision.

The cemented humeral stems are intended to be used with cement. The cementless humeral stems are intended to be used without cement, but in the event of insufficient primary fixation, only the diaphyseal portion of the stem may be cemented.

The metal-back glenoid base is intended to be used without cement and has associate cortical and cancellous bone screws.

1.4. Arrow II implants list

CEMENTED HUMERAL STEM

Reference	Diameter	Length (mm)
267 716	Ø6	L90
267 717	Ø8	L120
268 110	Ø8	L170
267 718	Ø10	L125
267 719	Ø12	L130

CEMENTLESS HUMERAL STEM

Reference	Diameter	Length (mm)
267 722	Ø8	L120
268 111	Ø8	L170
267 723	Ø10	L125
267 724	Ø12	L130
267 725	Ø14	L135
267 726	Ø16	L140

OFF-CENTERED HUMERAL HEAD +2

Reference	Diameter	Height (mm)
267 727	Ø42	H15 +2
267 728	Ø42	H17 +2
267 729	Ø45	H16 +2
267 730	Ø45	H19 +2
267 731	Ø48	H17 +2
267 732	Ø48	H20 +2
267 733	Ø51	H18 +2
267 734	Ø51	H22 +2
267 735	Ø54	H19 +2
267 736	Ø54	H23 +2

OFF-CENTERED HUMERAL HEAD +4

Reference	Diameter	Height (mm)
267 737	Ø39	H14 +4
267 738	Ø39	H16 +4
267 739	Ø42	H15 +4
267 740	Ø42	H17 +4
267 741	Ø45	H16 +4
267 742	Ø45	H19 +4
267 743	Ø48	H17 +4
267 744	Ø48	H20 +4
267 745	Ø51	H18 +4
267 746	Ø51	H22 +4

GLENOID INSERT

Reference	Size
267 768	XS-S
267 769	M
267 770	L

METAL-BACK GLENOID BASE PLATE

Reference	Size
267 771	S
267 772	M
267 773	L
267 713	XS-LP
267 714	S-LP
267 715	M-LP

CEMENTED GLENOID

Reference	Size
260 522	44/S
260 523	46/M
260 524	48/L
260 525	50/XL

STANDARD HUMERAL INSERT

Reference	Diameter	Height (mm)
267 747	Ø36	H00
267 748	Ø36	H05
267 749	Ø36	H10
267 750	Ø39	H00
267 751	Ø39	H05
267 752	Ø39	H10
267 753	Ø42	H00
267 754	Ø42	H05
267 755	Ø42	H10

OFF-CENTERED HUMERAL INSERT

Reference	Diameter	Height (mm)
267 756	Ø36	H00
267 757	Ø36	H05
267 758	Ø36	H10
267 759	Ø39	H00
267 760	Ø39	H05
267 761	Ø39	H10
267 762	Ø42	H00
267 763	Ø42	H05
267 764	Ø42	H10

GLENOSPHERE

Reference	Diameter
267 765	Ø36
267 766	Ø39
267 767	Ø42

CANCELLOUS BONE SCREW

Reference	Size
265 473	Ø5,5 - L24 (sterile)
263 468	Ø5,5 - L28 (sterile)
263 469	Ø5,5 - L32 (sterile)
263 470	Ø5,5 - L36 (sterile)
263 471	Ø5,5 - L40 (sterile)
263 472	Ø5,5 - L45 (sterile)
263 473	Ø5,5 - L50 (sterile)

CORTICAL BONE SCREW

Reference	Size
263 476	Ø4,5 - L32 (sterile)
263 477	Ø4,5 - L34 (sterile)
263 479	Ø4,5 - L36 (sterile)
263 480	Ø4,5 - L38 (sterile)
263 481	Ø4,5 - L40 (sterile)

SUTURES

Reference	Designation
267 253	ARROW LINK
271 203	FH LINK USP 2
271 636	FH TAPE 2 mm
271 635	FH LOOP USP2
271 630	FH LOOP TAPE 2 mm

SINGLE USE PIN

Reference	Dimensions
269 138	Ø3 - L170

SURGICAL TEMPLATING e-ORTHO FOR ARROW

Reference	Minimal quantity
271 192	5

 OPTIONAL

 ON REQUEST

2. Deltopectoral incision

a. The deltopectoral incision is made from the clavicle to the superior border of the pectoralis major, along the deltopectoral groove, lateral to the coracoid. The cephalic vein is reclined laterally.

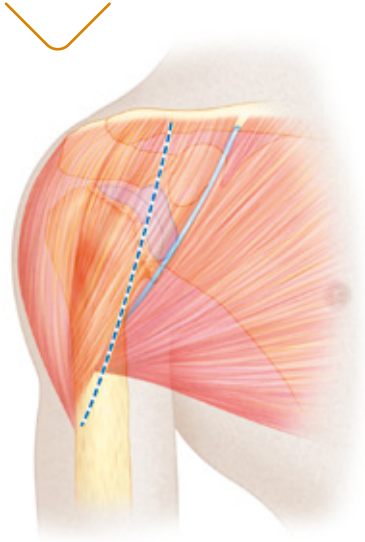

b. Find the position of the musculocutaneous nerve with the finger, before putting a retractor under the coracobrachialis muscle.

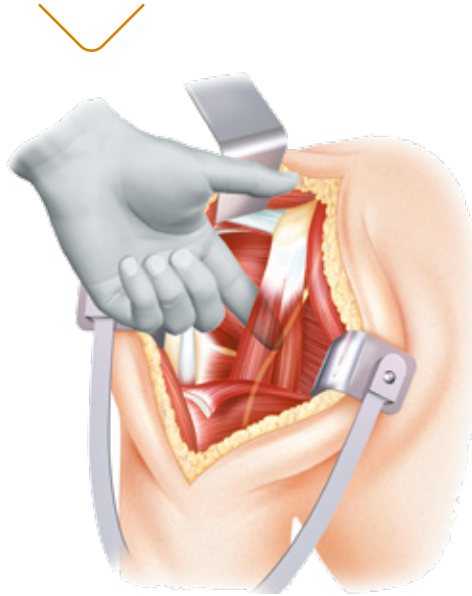

c. The position of the axillary nerve must be identified before sectioning the subscapularis muscle.

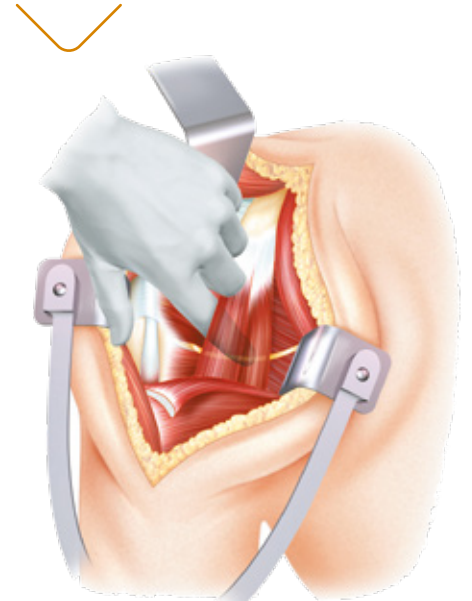

d. Free the deep surface of the deltoid by abducting and externally rotating the arm.

Do not damage the coracoacromial ligament.

Partially section the pectoralis major tendon for 1 cm (increasing external rotation).

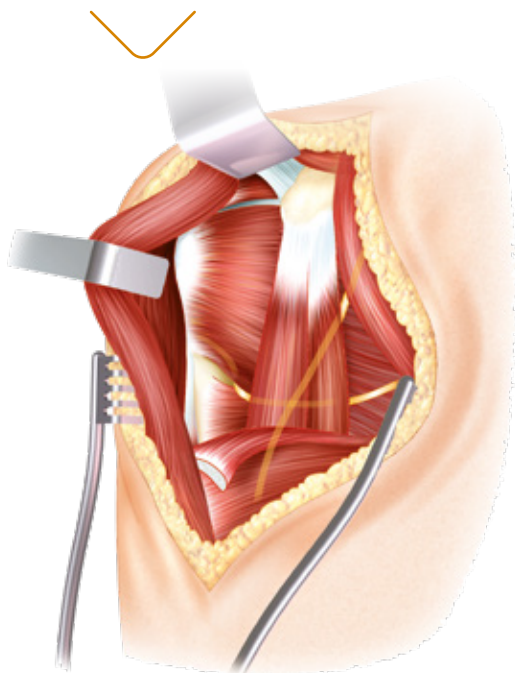

e. Ligate the anterior circumflex vessels.

Identify the rotator interval.

The subscapularis incision can be made in three ways:

- by sectioning the subscapularis muscle at the musculotendinous junction and sectioning the articular capsule at the same point;
- if there is limited preoperative external rotation, by detaching the subscapularis tendon subperiosteally starting from the bicipital groove (identified by the long head of the biceps at the superior border of the pectoralis major);
- by osteotomy of the lesser tuberosity to reduce the risk of secondary atrophy of the subscapularis.

In pathological conditions of the long head of the biceps:

- either a tenodesis is performed in the bicipital groove,
- or a tenotomy.

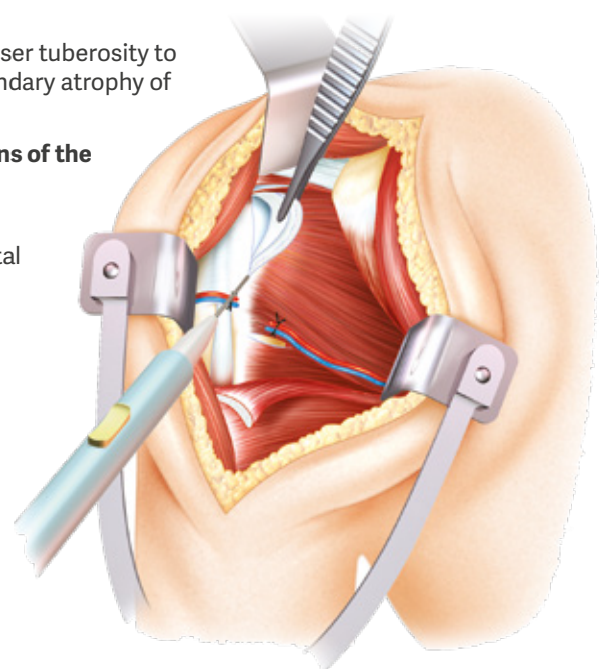

f. Dislocate the humeral head in abduction and external rotation with retropulsion of the arm.

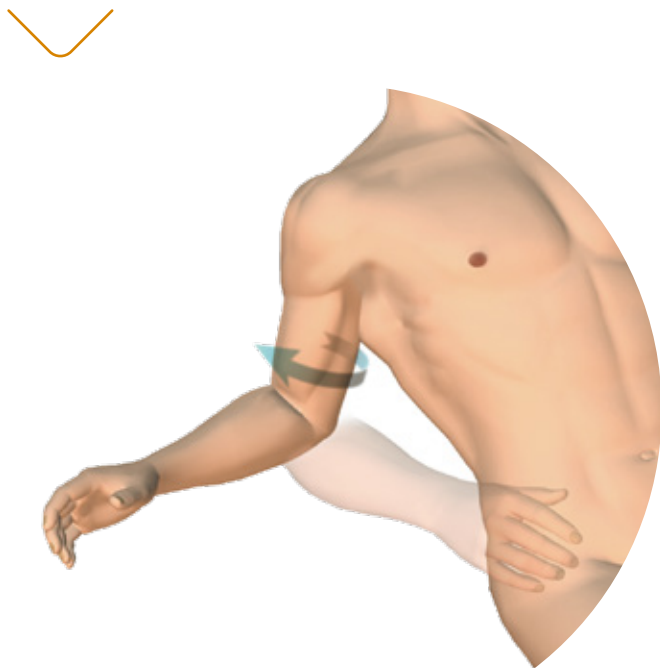

g. Dislocation is only possible if the anterior-inferior capsule and the coracohumeral ligament have been sectioned. Osteophytes on the anatomical neck of the humerus are resected using bone forceps.

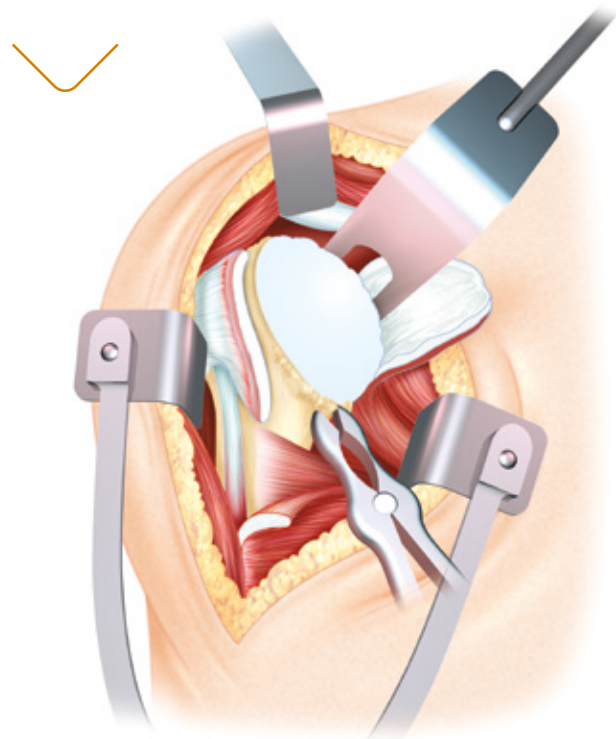

3. Humeral preparation

The entry point for the square-point awl is at the junction between the summit of the humeral head cartilage and the greater tuberosity, about 1 cm posteriorly and medially to the bicipital groove.

If the cortical bone is thick the $\varnothing 6$ reamer is recommended.

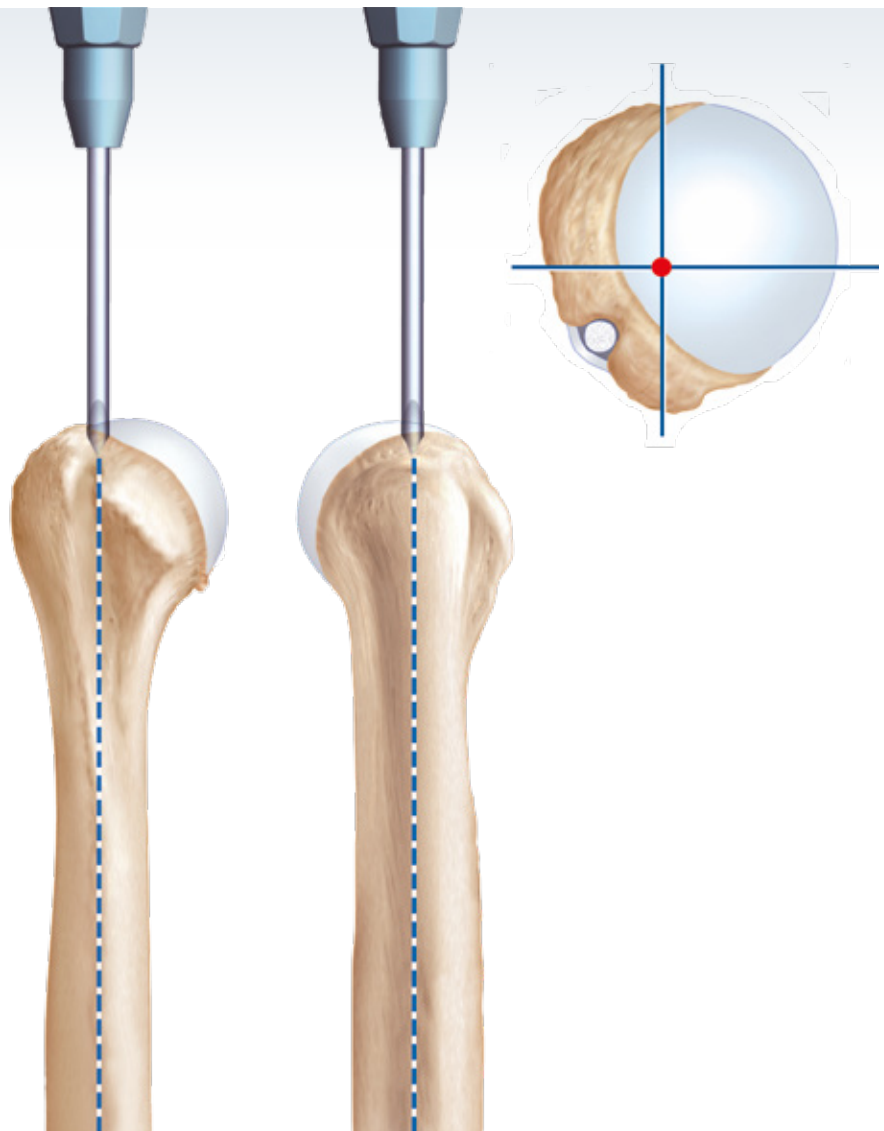

The length of the diaphyseal reamer allows the humeral stem to be aligned along the diaphyseal axis of the humerus in order to reduce the risk of varus/valgus malposition.



Perform diaphyseal reaming manually using increasing sizes of reamer (Ø6, 8, 10, 12, 14, 16) until there is a sensation of reaming into the cortex.



3.1. Use of the cutting guide

Assemble the cutting guide and the deltopectoral approach cutting block with the cutting guide screws. The guide can be used on the right or left side. The deltopectoral cutting block is positioned on the guide to clearly show the etched markings left or right side.

Having fixed the axis of the guide, gradually externally rotate the arm until the forearm is in line with the screwed retroversion shaft producing the angle chosen (0°, 10°, 20°, 30°, 40°). A retroversion of 20° is recommended for an anatomical prosthesis.

Put the humeral cutting guide onto the diaphyseal reamer. The top of the cut starts systematically at the summit of the head of the humerus, at the junction between the humeral head cartilage and the greater tuberosity.

With delto-pectoral approach, the superior pin is on the hollow of the anatomical neck.

The angulation of 135° is fixed. If needed, a recut is possible 5mm below the previous one.

When the depth of cut and degree of retroversion have been defined, fix the humeral cutting block with a maximum of 4 pins in the metaphysis. The pins can be impacted and removed with us of the pin holder.



The diaphyseal reamer is then removed.

Cut the head of the humerus using an oscillating saw along the groove in the humeral cutting block with a fixed angle of 135° and the selected retroversion.



The diameter and thickness of the articular head is measured with the humeral head template.

Remove any osteophytes before measuring.

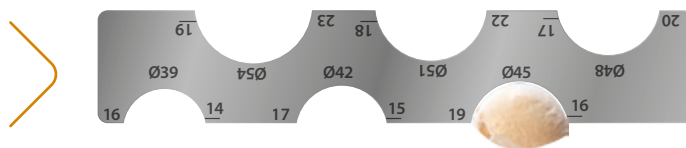

Reproduce the retroversion by aligning the forearm with the retroversion shaft (ref 261 053), fixed on the metaphyseal rasp handle. It is identical to that produced on the cutting guide.

The metaphysis is progressively prepared manually using increasing sizes of trial metaphyseal rasps.

The orientation of the metaphyseal ridges of the rasp compacts the cancellous bone and provides optimal stability for the implant.



Use the stem protector to protect the bone cutting surface during glenoid preparation

3.2. Choice of the humeral head

The humeral head should completely cover the bone surface of the cut humerus. By marking the reference position of the off-centered head on the bone with an electric scalpel the definitive humeral head can be similarly positioned.

Once the diameter and thickness of the humeral head has been chosen, check to see that the subscapularis can be repaired under tension (ER 30°).

There are 3 positions where the trial head of the humerus may completely cover the cut bone of the humerus.

However the top of the humeral head must be approximately 5 mm higher than the summit of the greater tuberosity.

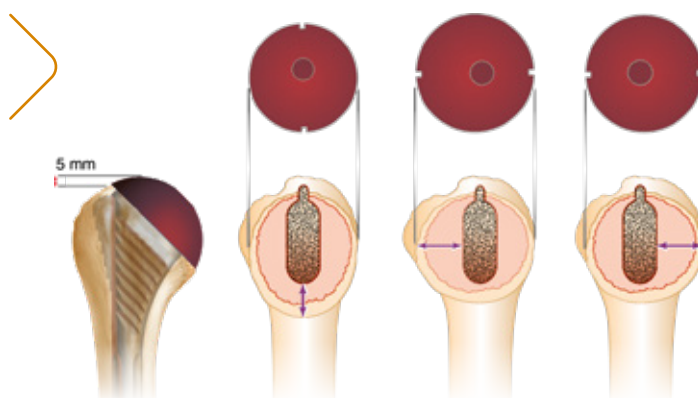

		GLENOID					
		MISMATCH	Size	S	M	L	XL
		Ø	Curvature radius	26	27	28	29
HEAD	39	19,5	6,5	7,5	8,5	9,5	
	42	21	5	6	7	8	
	45	22,5	3,5	4,5	5,5	6,5	
	48	24	2	3	4	5	
	51	25,5	0,5	1,5	2,5	3,5	
	54	27	-1	0	1	2	

We recommend a mismatch between 2 and 4 mm.

4. Glenoid preparation

Dislocate the upper end of the humerus downwards and backwards.

Exposure of the glenoid requires 4 retractors:

- a retractor in front,
- a retractor below, at 6 o'clock,
- a retractor posteriorly, at 8 o'clock (pushing back the humerus protected by the metaphyseal rasp),
- a retractor, protecting the anterior fascicle of the deltoid.

Capsulectomy and circumferential excision of the labrum (360°) helps to expose and delimit the glenoid.

The central glenoid hole is marked with the square-pointawl, using the most suitable glenoid template.

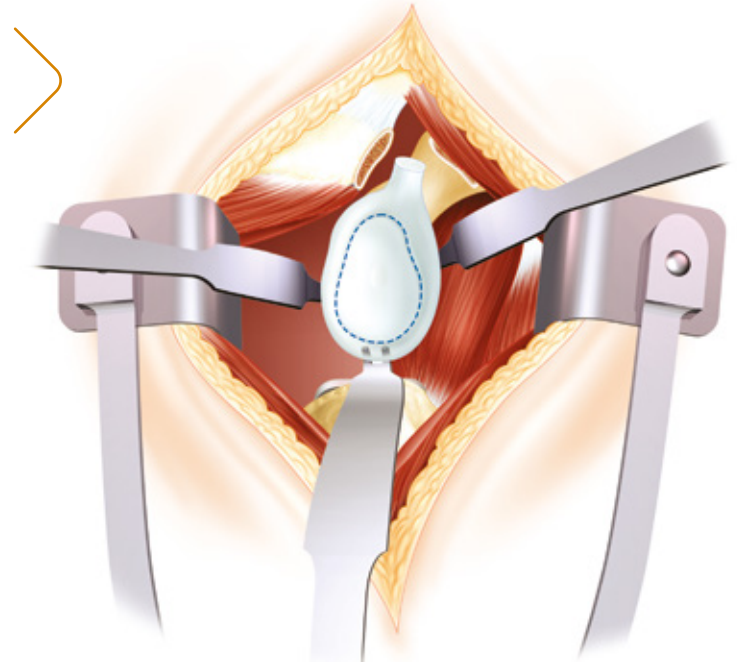

4.1. Guide pin positioning

1 Measurements on a preoperative CT-scan

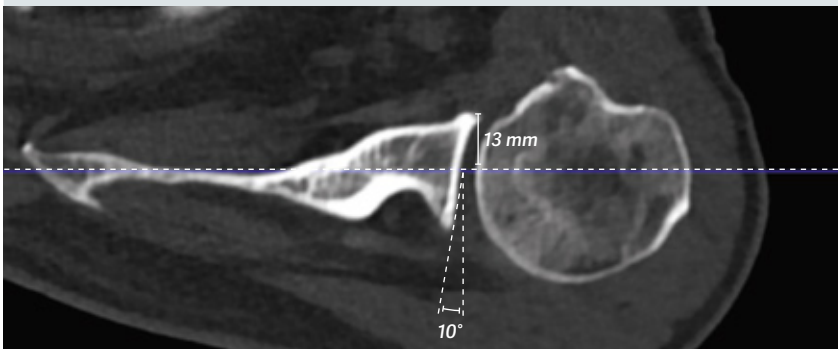

Guide choice:

- between 0°, 10° and 20° post compensation
- Left or right

Distance on the guide

2 E.g. use of left 10° guide

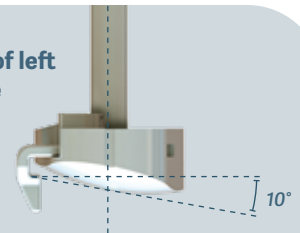

3 Length adjustment

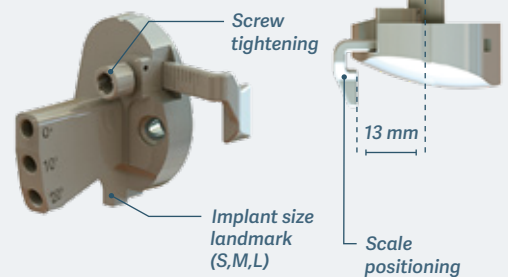

4 Tilt choice



Without superior erosion, we recommend 0 or 10° tilt.

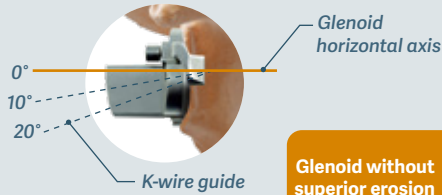

If the glenoid has a 10° superior erosion, the tilt must be chosen at:
 - 10° to have a tilt of 0°
 - 20° to have a tilt of 10°

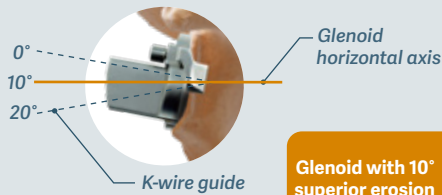

5

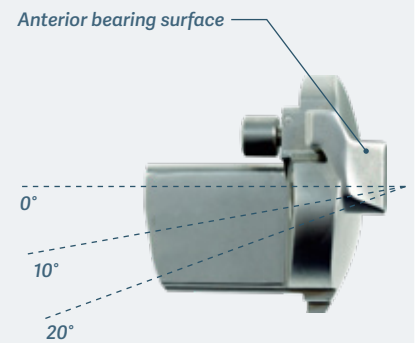

The guide is placed on the glenoid surface. The bearing surface must be in contact with the anterior glenoid. The guide pin is inserted with the previously selected tilt.



4.2. Glenoid bone preparation

Insert the guide pin into the glenoid reamer handle.

Openwork glenoid reamer (XS/S-M-L) is used to abrade the glenoid cavity while retaining the subchondral bone.

These are assembled on the glenoid reamer handle to be power-driven or manually used with the handle.

Initiate reamer a few millimeters off the bone to avoid risk of fracture.

Reaming creates a concave surface which fits perfectly with the convex base of the glenoid implant. (cemented glenoid or metal-back glenoid plate).

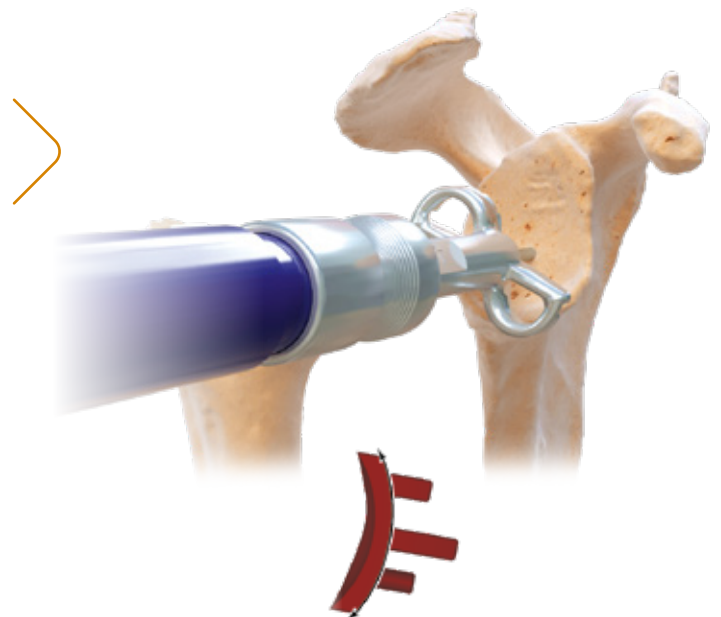

5. Cemented glenoid

5.1. Bone preparation

Place the glenoid template aligned with cardinal points of the glenoid. Then drill the first hole with the $\varnothing 5$ mm stopped drill bit.



Put the fixing pin to stabilize and drill the second hole.

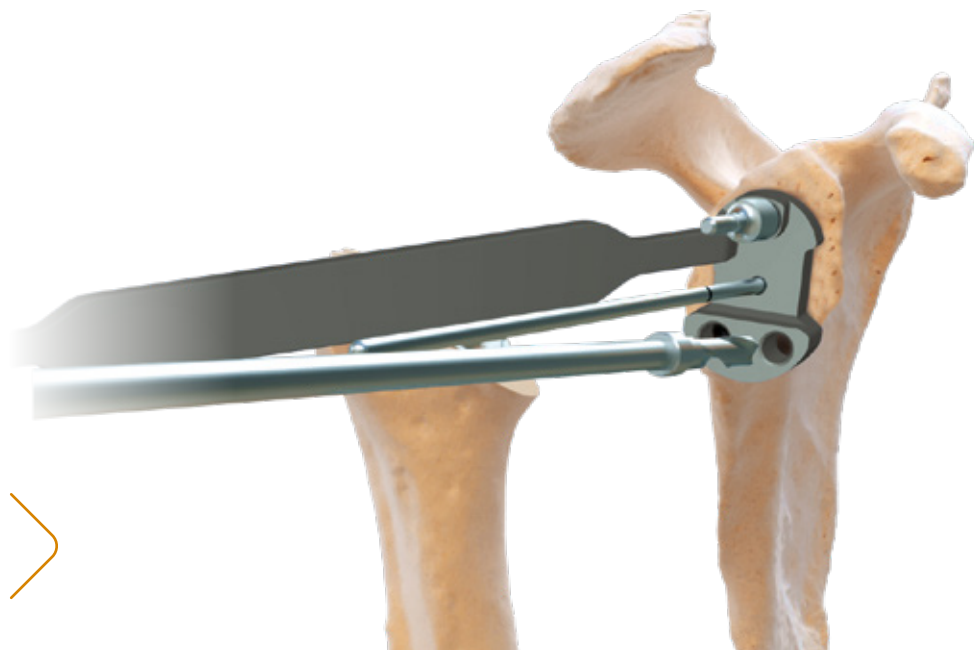

Remove the keel drill guide and use the cannulated tapered reamer to complete the central hole.

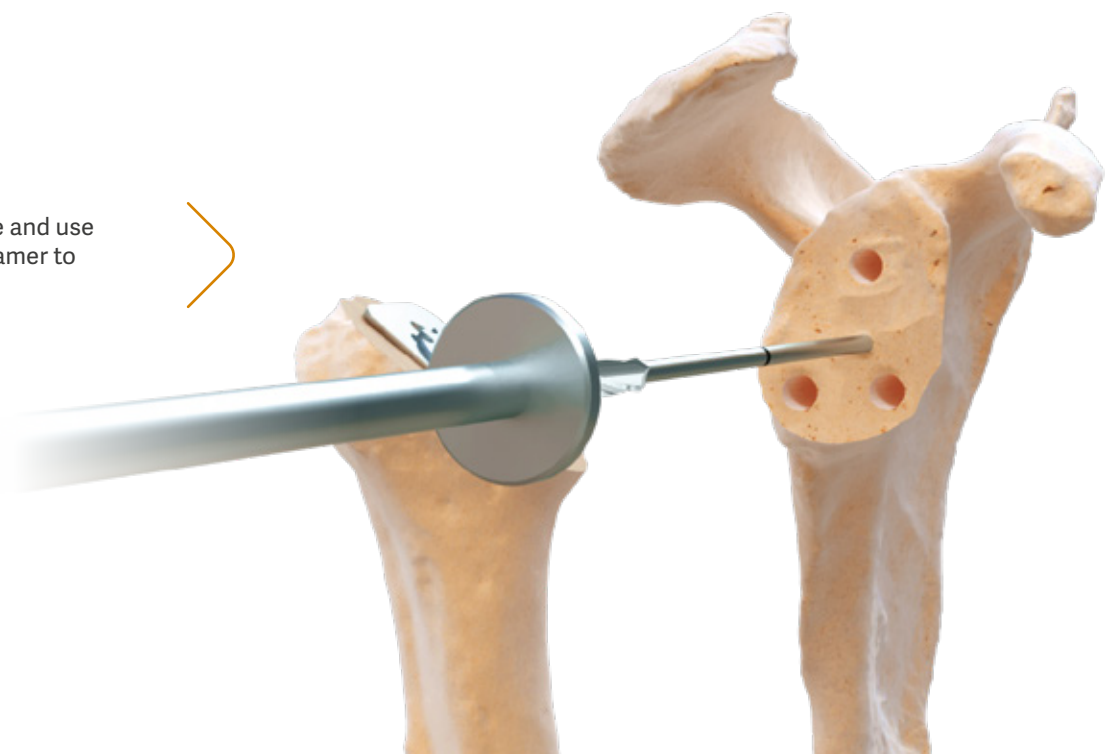

5.2. Prosthesis trial reduction

Put the chosen trial anatomical glenoid in place.

Tests performed:

- Anterior-posterior translation of the head of the humerus should be possible relative to the glenoid cavity (half a head).
- The head of the humerus should not project beyond the rotator cuff.
- The subscapularis should be reinserted with tension allowing external rotation of the elbow relative to the body of at least 30 to 40°.



5.3. Definitive implants

Clean and dry the glenoid fixing holes.

Introduce a moderate amount of cement into the 4 holes using a 20 cm syringe. avoid getting cement between the bone and the back of the glenoid prosthesis.

Place the glenoid with the forceps for holding glenoid unit. Impact the cemented glenoid with impactor and glenoid impaction tip.

Cement the definitive glenoid component in place and maintain it there by finger pressure or using a suitable means of applying pressure.

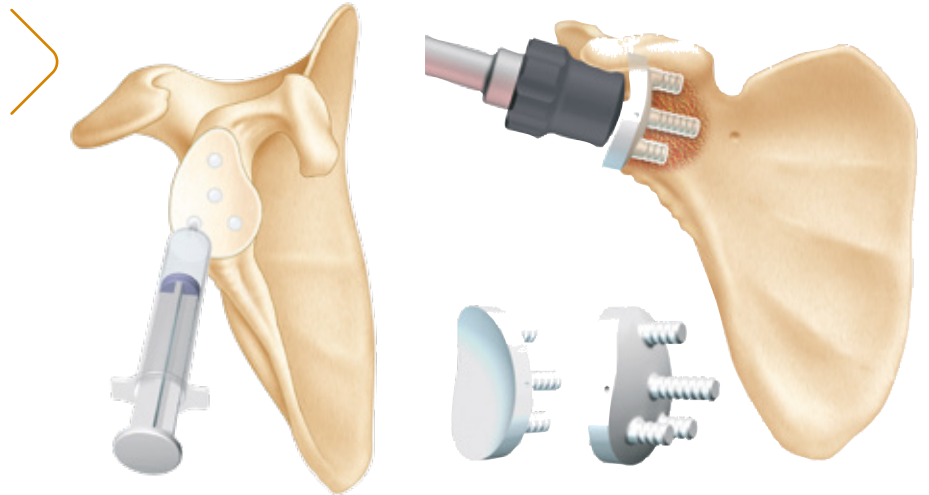

6. Cementless glenoid

6.1. Bone preparation

Place the glenoid template aligned with cardinal points of the glenoid. Then drill the first hole with the Ø5 mm stopped drill bit.

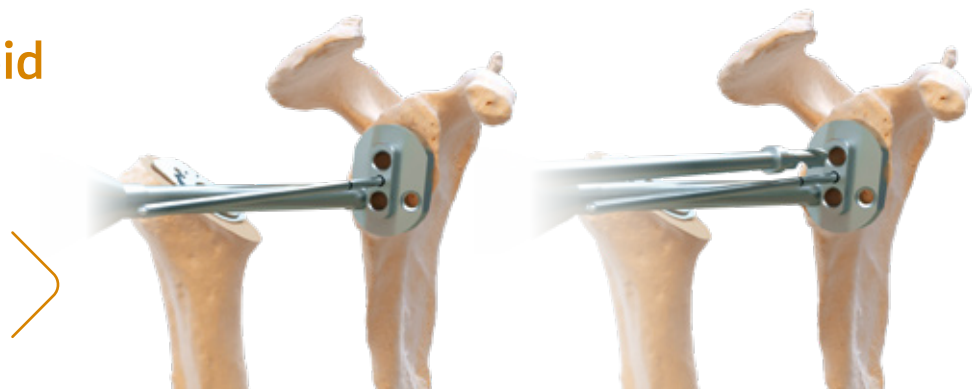

Put the fixing pin to stabilise and drill the second hole.



Use an oscillating saw to achieve an economical cut to accommodate the baseplate lateral winglet. Use the edge of the punch shield as a cutting surface.

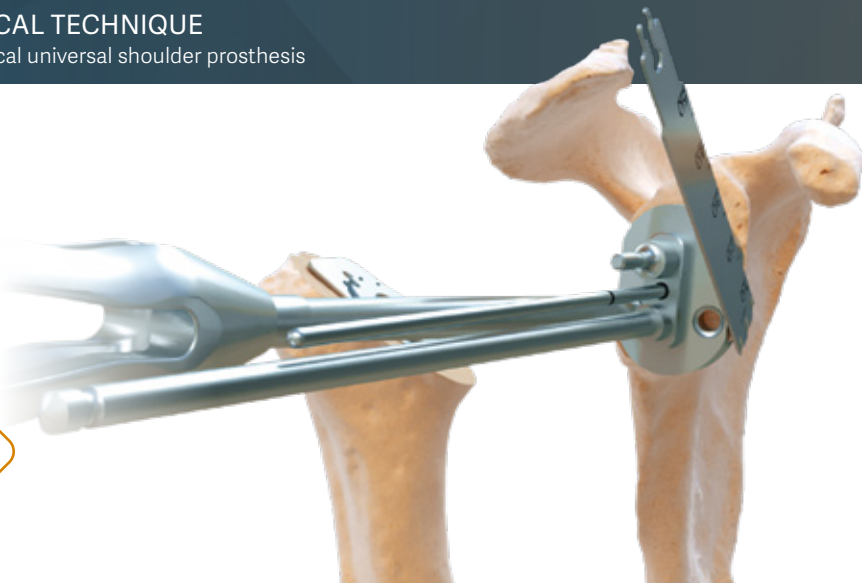

Remove the keel drill guide and use the cannulated tapered reamer to complete the central hole.

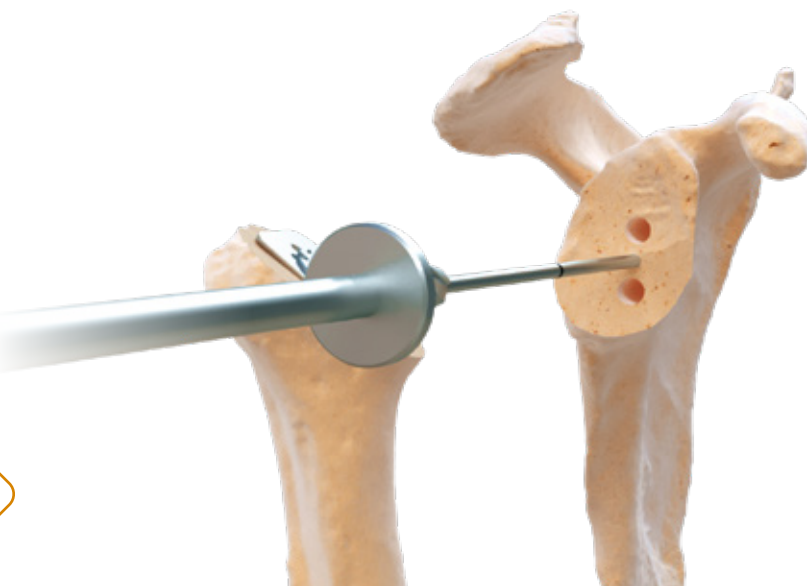

6.2. Metal-back glenoid base plate trial

Put in place trial metal back with the M5 handle. Verify primary stability and metal-back sitting on the glenoid surface otherwise review the knee preparation steps.

The thickness of the metal-back trial is equal to the definitive metal-back base plate with glenoid insert included.

6.3. Definitive implants

Impact the definitive metal-back glenoid base using the baseplate positioner/impactor.

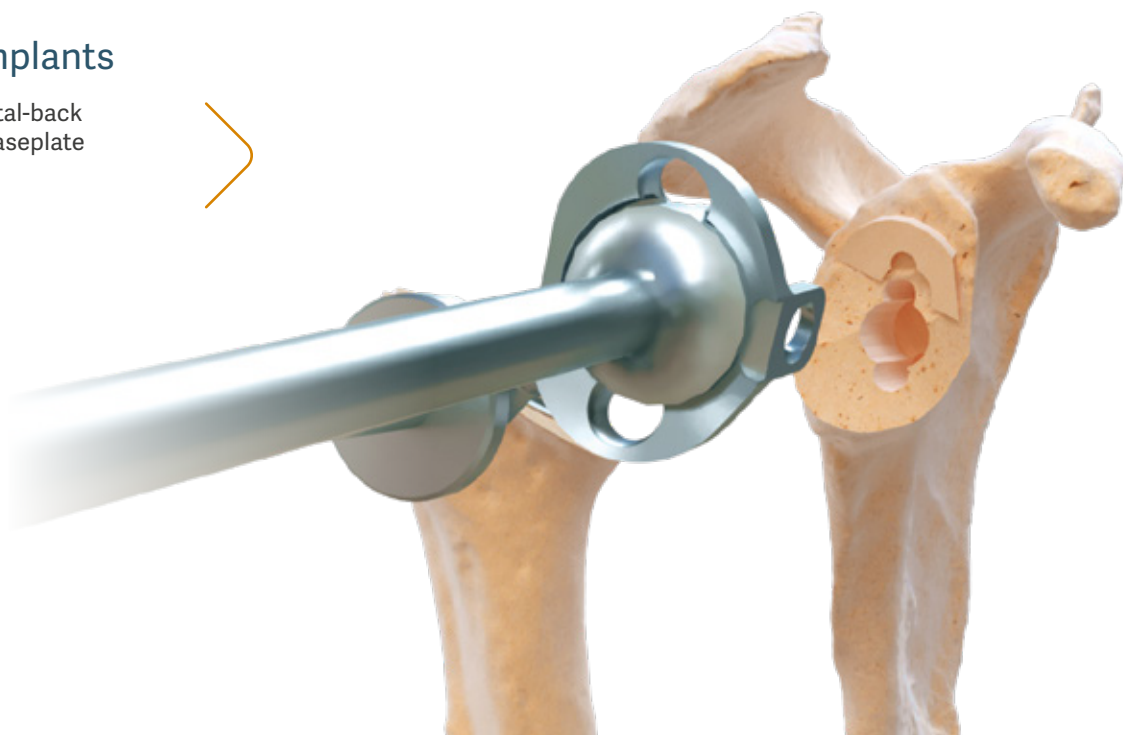

Axial screws orientation and placement

Drill the superior and inferior holes with the $\text{\O}3,2$ mm drill bit and screw sleeve. The best bone fixation areas can be sought because of tolerance of 10° .

The upper screw aims for the base of the coracoid and the lower screw aims for the pillar of the scapula.



- Read screw measurement on the graduation marks on the $\text{\O} 3,2$ drill bit or by positioning the depth gauge or reproducing e-ORTHO templating.
- Screw cancellous screws $\text{\O} 5,5$ by using the 6 sides screwdriver.

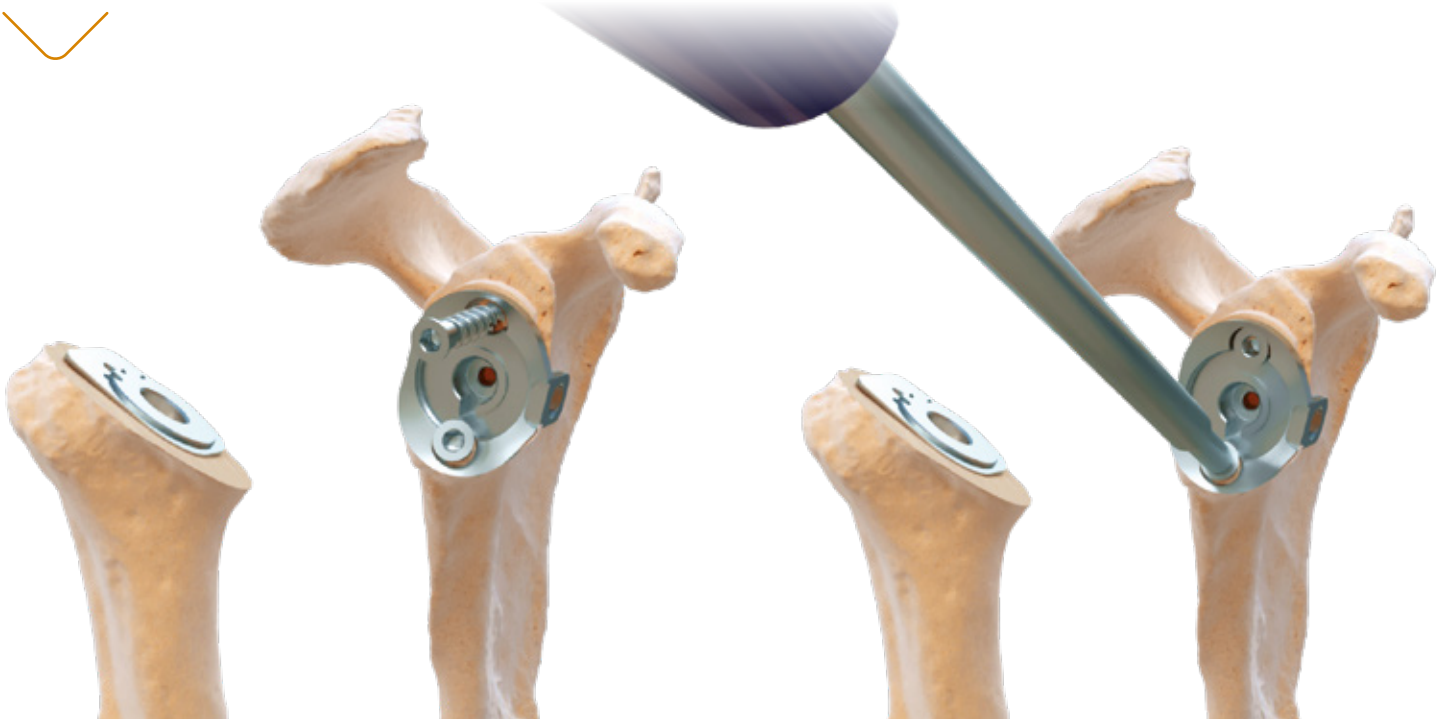

Option: fitting the anterior-posterior screw (optional)

This procedure is recommended for a bone graft or anterior glenoid fracture. A deltopectoral approach makes it easier. In the case of a superior-lateral approach, it could be done transcutaneously.

- Put the anterior-posterior guide for the metal-back glenoid base in place using the anterior-posterior guide handle.
- Put the screw and drill sleeves into the metal-back glenoid base sight. Drill with $\text{Ø}3,2$ mm drill bit. The length of the screw can't be read with this drill bit.
- Remove the drill sleeve and the drill bit, insert the depth gauge and measure the length of the screw ("cortical" writing front).
- Insert and drill the cortical screw $\text{Ø}4,5$ with the 6 sides screwdriver.

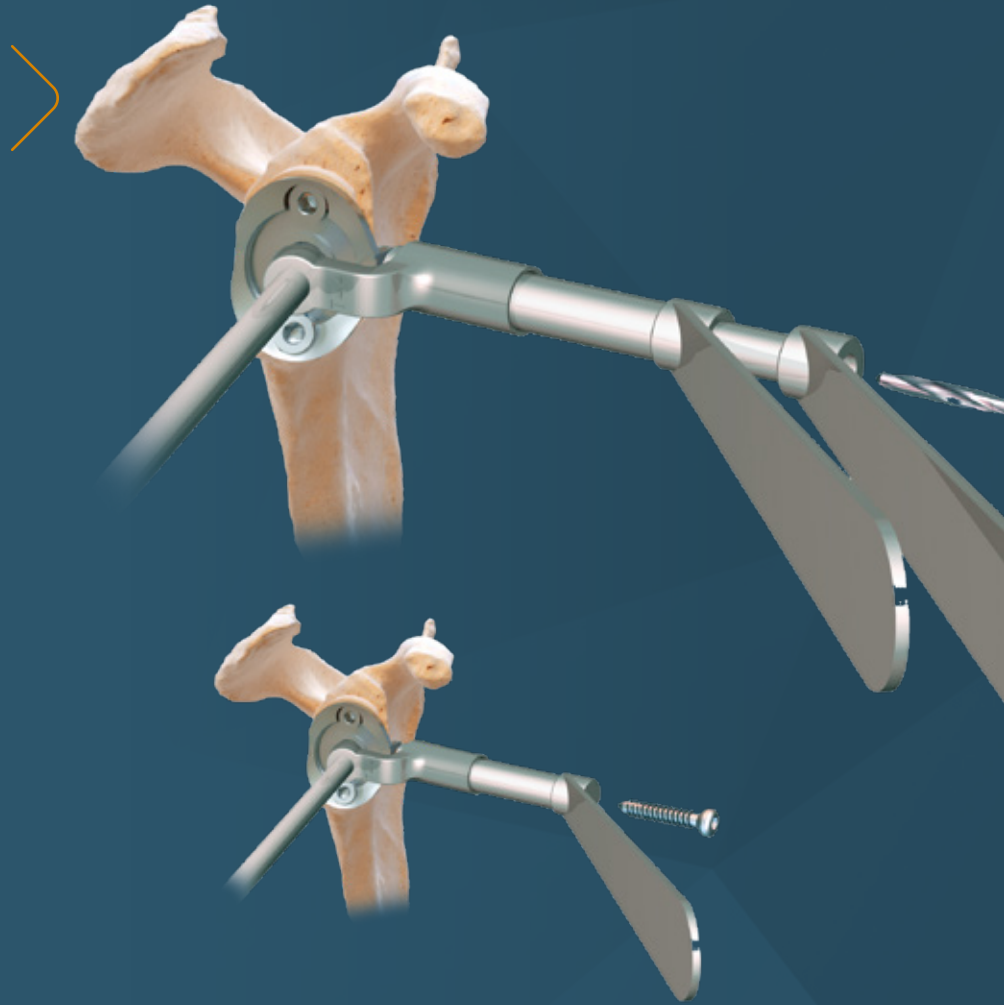

6.4 Glenoid insert impaction

Place the glenoid insert into the metal-back base plate and clip it with impactor and glenoid impaction tip.

Glenoid insert and metal-back base plate must share the same size.

Glenoid base plate	S	M	L	XS-LP	S-LP	M-LP
Glenoid insert	XS-S	M	L	XS-S	XS-S	M



7. Humeral definitive implants

7.1. Humeral stem

Grafts of spongy bone taken from the resected head of the humerus are put into the (inferior and anterior) metaphyseal region to ensure optimal stability for the definitive humeral stem.

Guide the retroversion using the shaft attached to the rasp handle aligned in the axis of the forearm.

Impact the humeral stem with or without cement in the smooth diaphyseal region, until the plate arrives in contact with the cut bone of the humerus.

Cemented stem is cementable on its complete surface : metaphysis and diaphysis

2 options:

- Cement the diaphyseal part of the humeral stem if the bone is osteoporotic, **OR**
- Press-fit the humeral prosthesis without cement, by using the metaphyseal cancellous bone.

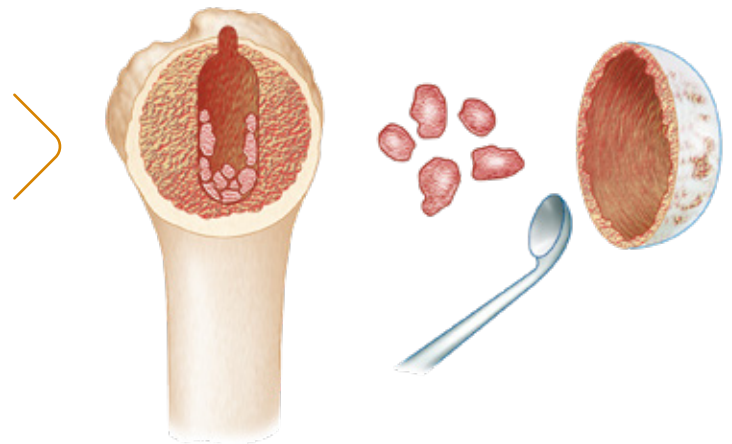

7.2. Humeral head

Put the humeral head in place using the humeral head forceps

Humeral insert is inclined at 155° and hollowed medially to avoid glenoid notching.

Impact the definitive centered or off-centered humeral head onto the definitive humeral stem using the head impaction piece. (Reproduce the trial position by using the marks previously made on the bone with an electric scalpel.)

The humeral head covers the plate and is very closely applied onto the cut bone of the humerus.

Reduce the humeral prosthesis.



8. Instrumentation

8.1. Universal humerus



- | | | | |
|---|-----------------|--|--------------|
| 1. ARROW Cutting guide..... | ref. 267 610 | 17. ARROW Protector for metaphysis | ref. 261 845 |
| 2. ARROW II Superior-lateral approach cutting guide | ref. 269 886 | 18. ARROW II Broach handle | ref. 267 614 |
| 3. ARROW II Cutting guide connecting screw..... | ref. 269 887 | 19. ARROW Head extractor..... | ref. 261 014 |
| 4. ARROW II Deltpectoral approach cutting guide..... | ref. 269 885 | 20. ARROW Trial rasp D6 L100..... | ref. 267 615 |
| 5. ARROW Reamer holder..... | ref. 261 054 | 21. ARROW Trial rasp D8 L120..... | ref. 267 616 |
| 6. ARROW Drill D6..... | ref. 261 010 | 22. ARROW Trial rasp D10 L125 | ref. 267 617 |
| 7. ARROW Cutting guide pins | ref. 264 460 | 23. ARROW Trial rasp D12 L130 | ref. 267 618 |
| | or ref. 261 056 | 24. ARROW Trial rasp D14 L135 | ref. 267 619 |
| 8. FHK Magnetic holder AO (optional)
(for 269 888) (OPTIONAL) | ref. 269 348 | 25. ARROW Impactor Handle | ref. 264 459 |
| 9. ARROW AO pin driver (for 268 016) (OPTIONAL) | ref. 269 239 | 26. ARROW II Standard humeral trial insert D36 H00..... | ref. 267 678 |
| 10. ARROW Retroversion rod..... | ref. 261 053 | 27. ARROW II Standard humeral trial insert D36 H05..... | ref. 267 679 |
| 11. ARROW Pin extractor | ref. 264 461 | 28. ARROW II Standard humeral trial insert D36 H10..... | ref. 267 680 |
| | or ref. 261 831 | 29. ARROW II Standard humeral trial insert D39 H00..... | ref. 267 681 |
| 12. ARROW Reamer D6..... | ref. 267 604 | 30. ARROW II Standard humeral trial insert D39 H05..... | ref. 267 682 |
| | or ref. 266 221 | 31. ARROW II Standard humeral trial insert D39 H10..... | ref. 267 683 |
| 13. ARROW Reamer D8..... | ref. 267 605 | 32. ARROW II Off-centered humeral trial insert D36 H00..... | ref. 267 687 |
| | or ref. 261 048 | 33. ARROW II Off-centered humeral trial insert D36 H05..... | ref. 267 688 |
| 14. ARROW Reamer D10..... | ref. 267 606 | 34. ARROW II Off-centered humeral trial insert D36 H10 | ref. 267 689 |
| | or ref. 261 049 | 35. ARROW II Off-centered humeral trial insert D39 H00..... | ref. 267 690 |
| 15. ARROW Reamer D12..... | ref. 267 607 | 36. ARROW II Off-centered humeral trial insert D39 H05..... | ref. 267 691 |
| | or ref. 261 050 | 37. ARROW II Off-centered humeral trial insert D39 H10 | ref. 267 692 |
| 16. ARROW Reamer D14..... | ref. 267 608 | | |
| | or ref. 261 051 | | |

8.2. Universal glenoid

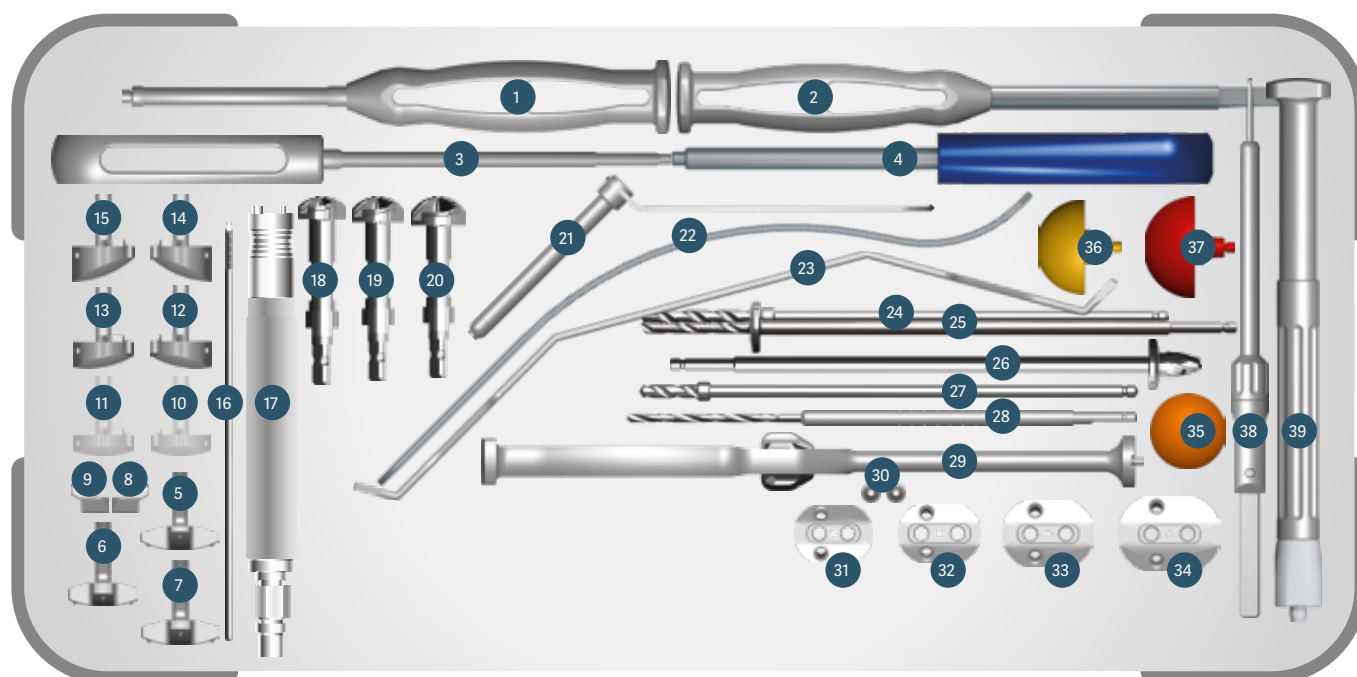

- | | | | |
|--|-----------------|---|--------------|
| 1. ARROW II Trial MB handle..... | ref. 267 667 | 20. ARROW Cannulated reamer L..... | ref. 267 652 |
| 2. ARROW chisel..... | or ref. 261 095 | 21. ARROW Barrel for drill..... | ref. 264 479 |
| 3. ARROW Screwdriver D3,5..... | ref. 270 827 | 22. ARROW Retractor..... | ref. 261 059 |
| 4. ARROW Handle for antero-posterior screw..... | or ref. 261 100 | 23. ARROW II Glenoid posterior retractor..... | ref. 269 890 |
| 5. ARROW II PTX Glenoid guide S44/S (WOS)..... | ref. 261 844 | 24. ARROW Stopped drill bit D5 for rev. glen. base..... | ref. 264 102 |
| 6. ARROW II PTX Glenoid guide S46/M (WOS)..... | ref. 269 892 | 25. ARROW Cannulated stop drill D5 long peg..... | ref. 267 649 |
| 7. ARROW II PTX Glenoid guide S48/L (WOS)..... | ref. 269 893 | 26. ARROW II Metal-back central peg drill bit..... | ref. 267 662 |
| 8. ARROW Glenoid guide stylus - right..... | ref. 269 894 | 27. ARROW Drill with end stop D5..... | ref. 261 069 |
| 9. ARROW Glenoid guide stylus - left..... | ref. 269 092 | 28. ARROW V7 Dia 3,2mm drill..... | ref. 264 472 |
| 10. ARROW Glenoid guide 0° post wear - right..... | ref. 269 093 | 29. ARROW II Glenoid base-plate impactor..... | ref. 267 674 |
| 11. ARROW Glenoid guide 0° post wear - left..... | ref. 269 086 | 30. ARROW Drilling guide fixing pins..... | ref. 261 058 |
| 12. ARROW Glenoid guide 10° post wear - right..... | or ref. 267 112 | 31. ARROW II Metal-back guide XS..... | ref. 267 663 |
| 13. ARROW Glenoid guide 10° post wear - left..... | ref. 269 087 | 32. ARROW II Metal-back guide S..... | ref. 267 664 |
| 14. ARROW Glenoid guide 20° post wear - right..... | ref. 269 088 | 33. ARROW II Metal-back guide M..... | ref. 267 665 |
| 15. ARROW Glenoid guide 20° post wear - left..... | ref. 269 089 | 34. ARROW II Metal-back guide L..... | ref. 267 666 |
| 16. ARROW Guide pin D3 L170 (OPTIONAL)..... | ref. 269 090 | 35. ARROW II Humeral insert impactor tip..... | ref. 267 696 |
| 17. ARROW Reamer handle AO Stryker Zier.Hall..... | ref. 265 423 | 36. ARROW II Glensphere trial D36..... | ref. 267 697 |
| or Glenoid reamer handle - Zier Hall - ZH..... | ref. 269 147 | 37. ARROW II Glensphere trial D39..... | ref. 267 698 |
| 18. ARROW Cannulated reamer XS-S..... | ref. 265 414 | 38. ARROW Depth gauge..... | ref. 269 241 |
| 19. ARROW Cannulated reamer M..... | ref. 267 651 | 39. ARROW Glensphere positioner/impactor..... | ref. 269 137 |

8.3. Universal anatomical

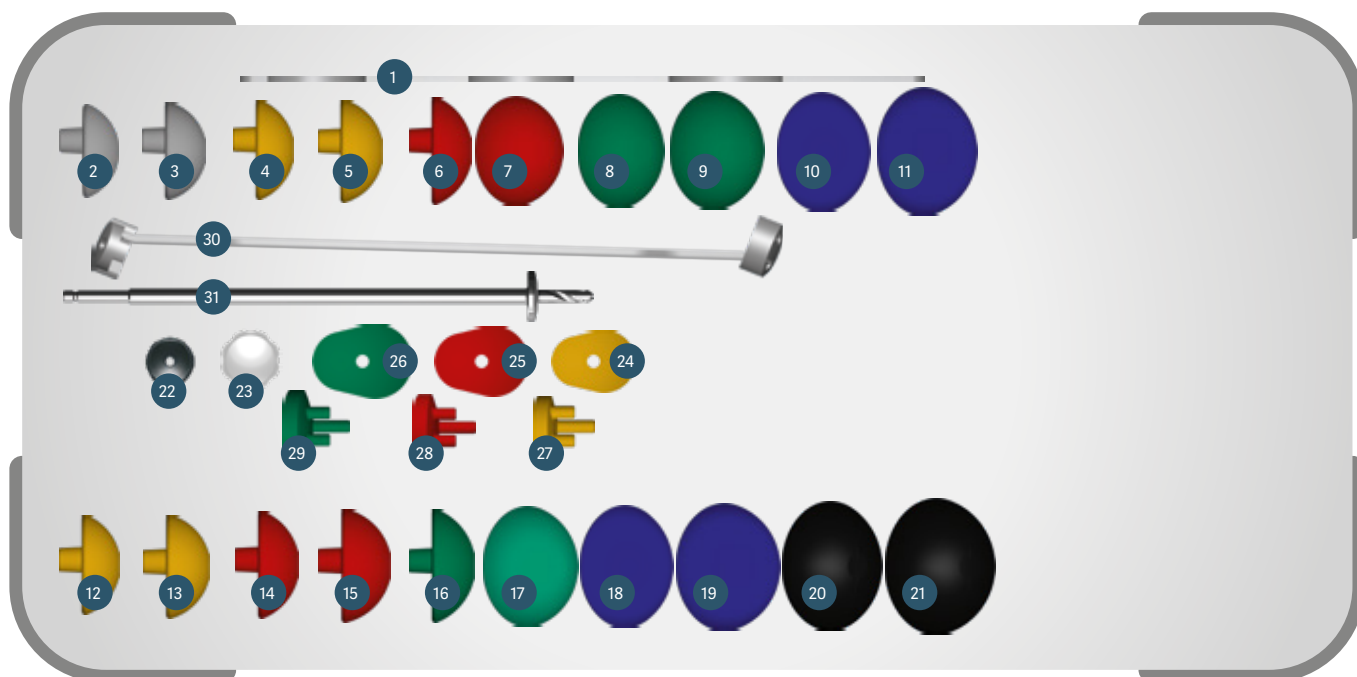

- | | |
|---|---|
| 1. ARROW II Humeral head sizer.....ref. 267 621 | 20. ARROW II Trial humeral head offset D54 H19 offset (+2).....ref. 267 630 |
| 2. ARROW II Trial humeral head offset D39 H14 offset (+4).....ref. 267 632 | 21. ARROW II Trial humeral head offset D54 H23 offset (+2).....ref. 267 631 |
| 3. ARROW II Trial humeral head offset D39 H16 offset (+4).....ref. 267 633 | 22. ARROW Head impactor tip.....ref. 261 043 |
| 4. ARROW II Trial humeral head offset D42 H15 offset (+4).....ref. 267 634 | 23. ARROW PE Glenoid impaction tip.....ref. 267 659
or ref. 261 081 |
| 5. ARROW II Trial humeral head offset D42 H17 offset (+4).....ref. 267 635 | 24. ARROW II Glenoid template XS-S.....ref. 267 644
or ref. 261 077 |
| 6. ARROW II Trial humeral head offset D45 H16 offset (+4).....ref. 267 636 | 25. ARROW II Glenoid template M.....ref. 267 645
or ref. 261 078 |
| 7. ARROW II Trial humeral head offset D45 H19 offset (+4).....ref. 267 637 | 26. ARROW II Glenoid template L.....ref. 267 646
or ref. 261 079 |
| 8. ARROW II Trial humeral head offset D48 H17 offset (+4).....ref. 267 638 | 27. ARROW II C/M trial glenoid S.....ref. 267 655
or ref. 261 070 |
| 9. ARROW II Trial humeral head offset D48 H20 offset (+4).....ref. 267 639 | 28. ARROW II C/M trial glenoid M.....ref. 267 656
or ref. 261 071 |
| 10. ARROW II Trial humeral head offset D51 H18 offset (+4).....ref. 267 640 | 29. ARROW II C/M trial glenoid L.....ref. 267 657
or ref. 261 072 |
| 11. ARROW II Trial humeral head offset D51 H22 offset (+4).....ref. 267 641 | 30. ARROW II Full PE drilling guide.....ref. 267 654 |
| 12. ARROW II Trial humeral head offset D42 H15 offset (+2).....ref. 267 622 | 31. ARROW Cannulated stop drill D5.....ref. 267 648 |
| 13. ARROW II Trial humeral head offset D42 H17 offset (+2).....ref. 267 623 | |
| 14. ARROW II Trial humeral head offset D45 H16 offset (+2).....ref. 267 624 | |
| 15. ARROW II Trial humeral head offset D45 H19 offset (+2).....ref. 267 625 | |
| 16. ARROW II Trial humeral head offset D48 H17 offset (+2).....ref. 267 626 | |
| 17. ARROW II Trial humeral head offset D48 H20 offset (+2).....ref. 267 627 | |
| 18. ARROW II Trial humeral head offset D51 H18 offset (+2).....ref. 267 628 | |
| 19. ARROW II Trial humeral head offset D51 H22 offset (+2).....ref. 267 629 | |

8.4. Option universal revision

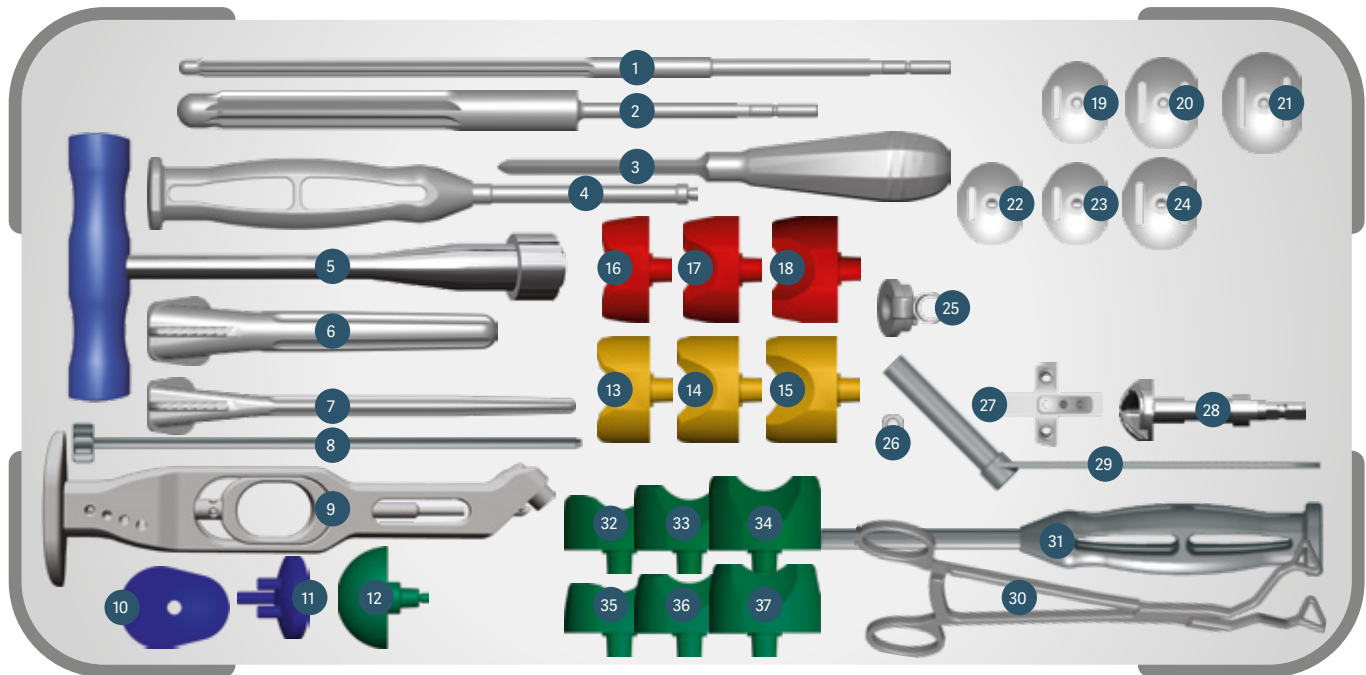

- | | |
|---|---|
| 1. ARROW Reamer D8 L200.....ref. 268 108
or ref. 257 333 | 18. ARROW* Standard humeral trial insert D39 H10.....ref. 257 318
or ref. 264 500 |
| 2. ARROW Reamer D16 L140.....ref. 267 609
or ref. 267 356 | 19. ARROW II Trial MB glenoid base-plate S.....ref. 267 668 |
| 3. Square awl.....ref. 264 868 | 20. ARROW II Trial MB glenoid base-plate SC M.....ref. 267 669 |
| 4. ARROW II Trial MB handle.....ref. 267 667 | 21. ARROW II Trial MB glenoid base-plate SC L.....ref. 267 670 |
| 5. ARROW T handle long.....ref. 261 076 | 22. ARROW II Trial MB glenoid base-plate SC XS Long.....ref. 267 671 |
| 6. ARROW II Trial rasp D16 L140.....ref. 267 620 | 23. ARROW II Trial MB glenoid base-plate SC S Long.....ref. 267 672 |
| 7. ARROW II Trial rasp D8 L170.....ref. 268 109 | 24. ARROW II Trial MB glenoid base-plate SC M Long.....ref. 267 673 |
| 8. ARROW Retroversion rod.....ref. 261 053 | 25. ARROW II AP screw drilling guide.....ref. 267 675 |
| 9. ARROW II Broach handle.....ref. 267 614 | 26. ARROW V7 Connecting screw for lateral guide.....ref. 264 478 |
| 10. ARROW II Glenoid template XL.....ref. 267 647 | 27. ARROW II PTX glenoid guide S50/XL (WOS).....ref. 269 895 |
| 11. ARROW II C/M Trial glenoid XL.....ref. 267 658 | 28. ARROW Cannulated reamer XL.....ref. 267 653 |
| 12. ARROW II Trial glenosphere D42.....ref. 267 699 | 29. ARROW Barrel for screw.....ref. 261 846 |
| 13. ARROW* Standard humeral trial insert D36 H00.....ref. 261 096
or ref. 264 495 | 30. ARROW Glenoid inserter.....ref. 267 110 |
| 14. ARROW* Standard humeral trial insert D36 H05.....ref. 261 097
or ref. 264 496 | 31. ARROW Glenosphere positioner/impactor.....ref. 261 101 |
| 15. ARROW* Standard humeral trial insert D36 H10.....ref. 257 317
or ref. 264 497 | 32. ARROW II Standard humeral trial insert D42 H00.....ref. 267 684 |
| 16. ARROW* Standard humeral trial insert D39 H00.....ref. 261 098
or ref. 264 498 | 33. ARROW II Standard humeral trial insert D42 H05.....ref. 267 685 |
| 17. ARROW* Standard humeral trial insert D39 H05.....ref. 261 099
or ref. 264 499 | 34. ARROW II Standard humeral trial insert D42 H10.....ref. 267 686 |
| | 35. ARROW II Off-centered humeral trial insert D42 H00.....ref. 267 693 |
| | 36. ARROW II Off-centered humeral trial insert D42 H05.....ref. 267 694 |
| | 37. ARROW II Off-centered humeral trial insert D42 H10.....ref. 267 695 |

* Arrow I trial implants in case of revision



**DISTRIBUTEURS
DISTRIBUTORS**

FR, FH ORTHO SAS
3 rue de la Forêt - Zone Industrielle
BP 50009
68990 Heimsbrunn CEDEX - FRANCE
Tél. +33 (0)3 89 81 90 92
Fax : +33 (0)3 89 81 80 11
info@fhortho.com
www.fhortho.com

USA, FH ORTHOPEDICS INC.
OrthoEx
7327 E Tierra Buena Lane
Scottsdale, Arizona 85260 - USA
Phone: +1 (412) 965-0950
customerservice@fhortho-us.com
www.fhortho.com

PL, FH ORTHO POLSKA
Ul. Garbary 95/A6,
61-757 Poznan - POLSKA
Phone: +48 61 863 81 27
Fax: +48 61 863 81 28
biuro@implants24.pl
www.fhortho.com



**FABRICANT
MANUFACTURER**

FR, FH INDUSTRIE
6 rue Nobel, Z.I. de Kernevez
29000 QUIMPER - FRANCE
Tél. +33 (0)2 98 55 68 95
Fax : +33 (0)2 98 53 42 13
contact-fhi@fhortho.com
www.fhortho.com