

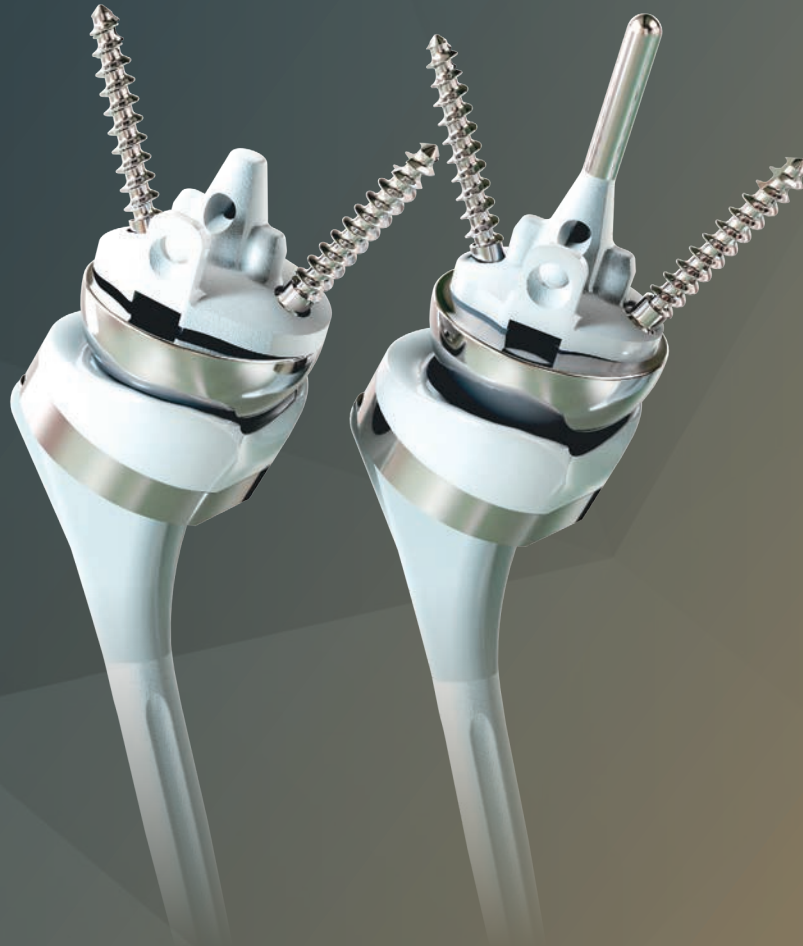

ARROW



ARROW II

Universal shoulder prosthesis

SURGICAL TECHNIQUE

REVERSE

GROUP
FH ORTHO™

TABLE OF CONTENTS

1. Arrow II implant range	4
1.1. Range description	4
1.2. Indications	4
1.3. Use	4
1.4. Arrow II implants list	5
2. Superior-lateral incision	6
3. Deltopectoral incision	6
4. Humeral preparation	8
4.1. Use of the cutting guide	9
4.2. Humeral stem trials	10
5. Glenoid preparation	10
5.1. Positionnement de la broche guide	10
5.2. Glenoid bone preparation	12
5.3. Bone preparation for metal-back	12
5.4. Definitive metal-back glenoid plate	14
6. Full trail test	16
6.1. Trial glenosphere (optional)	16
6.2. Trial humeral insert	16
7. Definitive implants	16
7.1. Glenosphere	16
7.2. Humeral stem	16
7.3. Humeral insert	17
7.4. Full test	17
8. Instrumentation	18
8.1. Universal humerus	18
8.2. Universal glenoid	19
8.3. Universal anatomical	20
8.4. Option universal revision	21

1. Arrow II implant range

1.1. Range description



1.2. Indications

Reverse prosthesis

- Glenohumeral osteoarthritis with an insufficient cuff,
- Massive rotator cuff tear with pseudoparalysis of the shoulder,
- Complex fracture of the proximal end of the humerus,
- Revision of failed arthroplasty or another surgery with a damaged cuff,
- Post-traumatic sequelae with a damaged cuff.

A functional deltoid muscle is needed to use this device.

1.3. Use

All shoulder prosthesis implants are intended to be used for primary shoulder arthroplasty or for revision.

The cemented humeral stems are intended to be used with cement. The cementless humeral stems are intended to be used without cement, but in the event of insufficient primary fixation, only the diaphyseal portion of the stem may be cemented.

The metal-back glenoid base is intended to be used without cement and has associate cortical and cancellous bone screws.

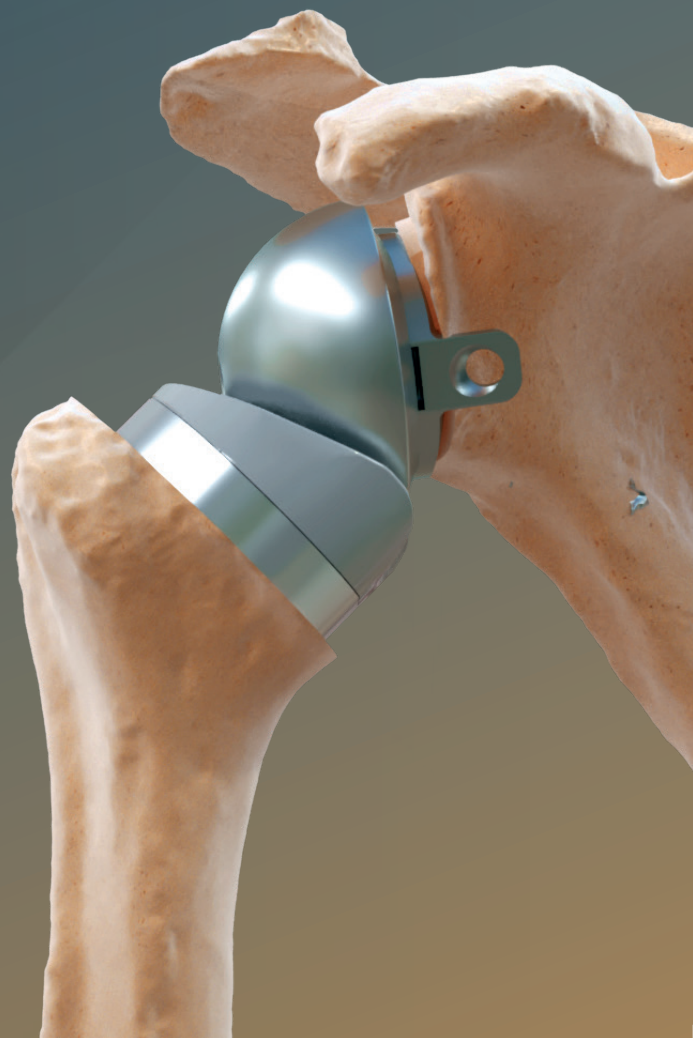

1.4. Arrow II implants list

CEMENTED HUMERAL STEM

Reference	Diameter	Length (mm)
267 716	Ø6	L90
267 717	Ø8	L120
268 110	Ø8	L170
267 718	Ø10	L125
267 719	Ø12	L130

CEMENTLESS HUMERAL STEM

Reference	Diameter	Length (mm)
267 722	Ø8	L120
268 111	Ø8	L170
267 723	Ø10	L125
267 724	Ø12	L130
267 725	Ø14	L135
267 726	Ø16	L140

OFF-CENTERED HUMERAL HEAD +2

Reference	Diameter	Height (mm)
267 727	Ø42	H15 +2
267 728	Ø42	H17 +2
267 729	Ø45	H16 +2
267 730	Ø45	H19 +2
267 731	Ø48	H17 +2
267 732	Ø48	H20 +2
267 733	Ø51	H18 +2
267 734	Ø51	H22 +2
267 735	Ø54	H19 +2
267 736	Ø54	H23 +2

OFF-CENTERED HUMERAL HEAD +4

Reference	Diameter	Height (mm)
267 737	Ø39	H14 +4
267 738	Ø39	H16 +4
267 739	Ø42	H15 +4
267 740	Ø42	H17 +4
267 741	Ø45	H16 +4
267 742	Ø45	H19 +4
267 743	Ø48	H17 +4
267 744	Ø48	H20 +4
267 745	Ø51	H18 +4
267 746	Ø51	H22 +4

GLENOID INSERT

Reference	Size
267 768	XS-S
267 769	M
267 770	L

METAL-BACK GLENOID BASE PLATE

Reference	Size
267 771	S
267 772	M
267 773	L
267 713	XS-LP
267 714	S-LP
267 715	M-LP

CEMENTED GLENOID

Reference	Size
260 522	44/S
260 523	46/M
260 524	48/L
260 525	50/XL

STANDARD HUMERAL INSERT

Reference	Diameter	Height (mm)
267 747	Ø36	H00
267 748	Ø36	H05
267 749	Ø36	H10
267 750	Ø39	H00
267 751	Ø39	H05
267 752	Ø39	H10
267 753	Ø42	H00
267 754	Ø42	H05
267 755	Ø42	H10

OFF-CENTERED HUMERAL INSERT

Reference	Diameter	Height (mm)
267 756	Ø36	H00
267 757	Ø36	H05
267 758	Ø36	H10
267 759	Ø39	H00
267 760	Ø39	H05
267 761	Ø39	H10
267 762	Ø42	H00
267 763	Ø42	H05
267 764	Ø42	H10

GLENOSPHERE

Reference	Diameter
267 765	Ø36
267 766	Ø39
267 767	Ø42

CANCELLOUS BONE SCREW

Reference	Size
265 473	Ø5,5 - L24 (sterile)
263 468	Ø5,5 - L28 (sterile)
263 469	Ø5,5 - L32 (sterile)
263 470	Ø5,5 - L36 (sterile)
263 471	Ø5,5 - L40 (sterile)
263 472	Ø5,5 - L45 (sterile)
263 473	Ø5,5 - L50 (sterile)

CORTICAL BONE SCREW

Reference	Size
263 476	Ø4,5 - L32 (sterile)
263 477	Ø4,5 - L34 (sterile)
263 479	Ø4,5 - L36 (sterile)
263 480	Ø4,5 - L38 (sterile)
263 481	Ø4,5 - L40 (sterile)

SUTURES

Reference	Designation
271 635	FH LOOP USP 2 (black)
271 200	FH LOOP USP 2 (blue)
271 630	FH LOOP TAPE 2.2 mm (black)
271 202	FH LOOP TAPE 2.3 mm (blue)
271 636	FH TAPE 2 mm
271 203	FH LINK USP 2

SINGLE USE PIN

Reference	Dimensions
269 138	Ø3 - L170

SURGICAL TEMPLATING e-ORTHO FOR ARROW

Reference	Minimal quantity
271 192	5

- OPTIONAL
- ON REQUEST

2. Superior-lateral incision

a. Start the incision at the acromioclavicular joint. Follow the anterior border of the acromion descending onto the lateral surface of the shoulder to 4 to 5 cm from the anterior lateral border of the acromion.

A deltopectoral incision (classic) may also be used if the surgeon is more familiar with this.

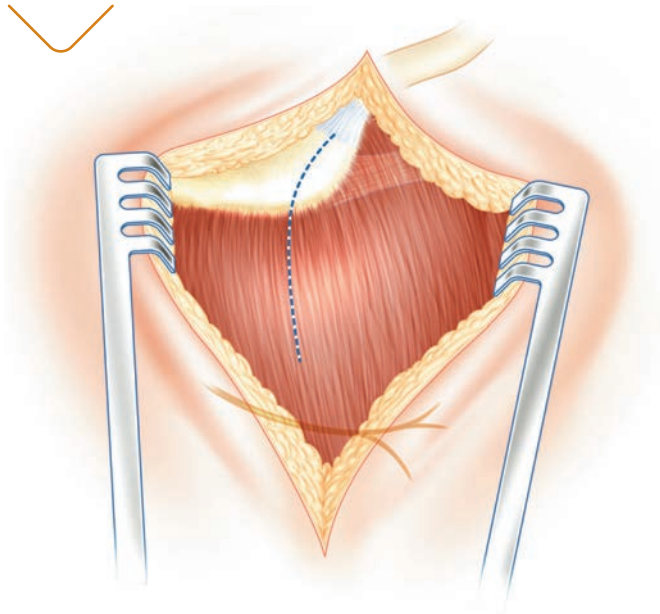

b. Detach the deltoid from the anterior border of the acromion, together with osteoperiosteal shavings (to assist in its repair), then divide it in the direction of its fibres, without descending too far thus avoiding the axillary nerve.

If required perform an acromioplasty, resecting the coracoacromial ligament (facilitating the exposure of the bare head of the humerus).

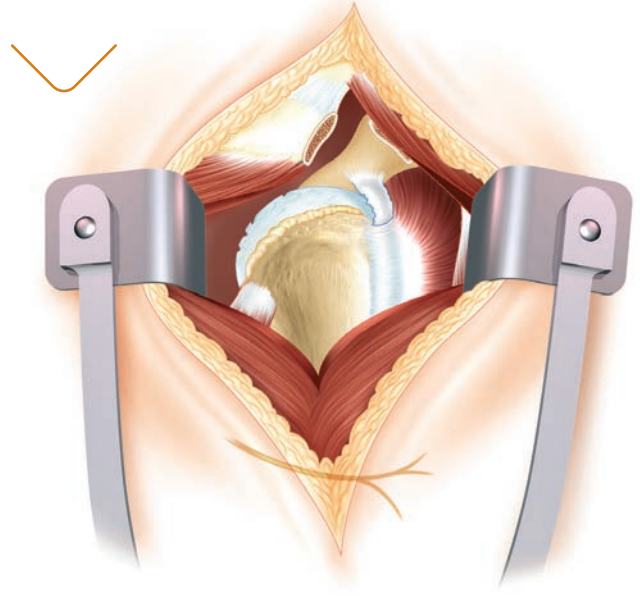

3. Deltopectoral incision

a. The deltopectoral incision is made from the clavicle to the superior border of the pectoralis major, along the deltopectoral groove, lateral to the coracoid. The cephalic vein is reclined laterally.

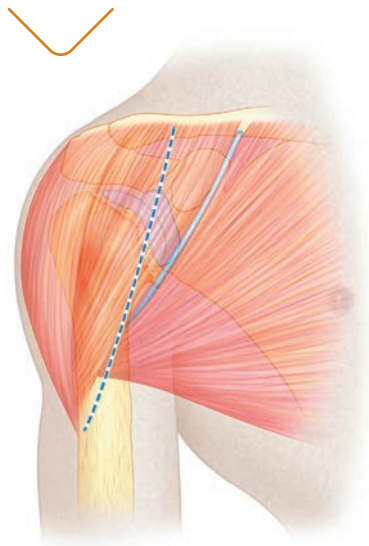

b. Find the position of the musculocutaneous nerve with the finger, before putting a retractor under the coracobrachialis muscle.

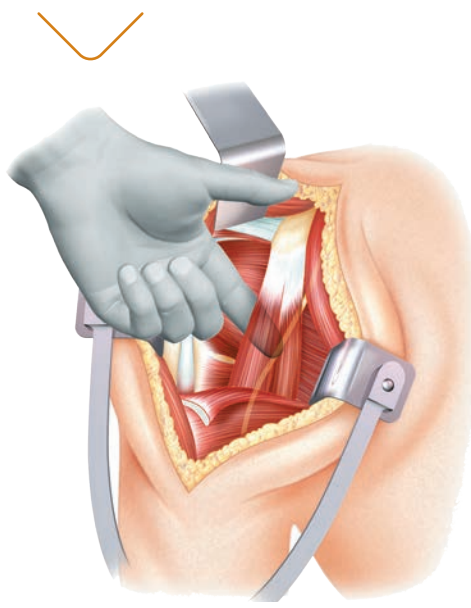

c. The position of the axillary nerve must be identified before sectioning the subscapularis muscle.

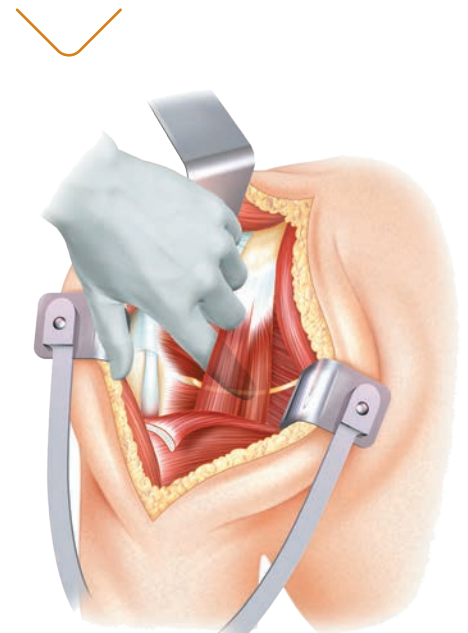

- d. Free the deep surface of the deltoid by abducting and externally rotating the arm.

Do not damage the coracoacromial ligament.

Partially section the pectoralis major tendon for 1 cm (increasing external rotation).

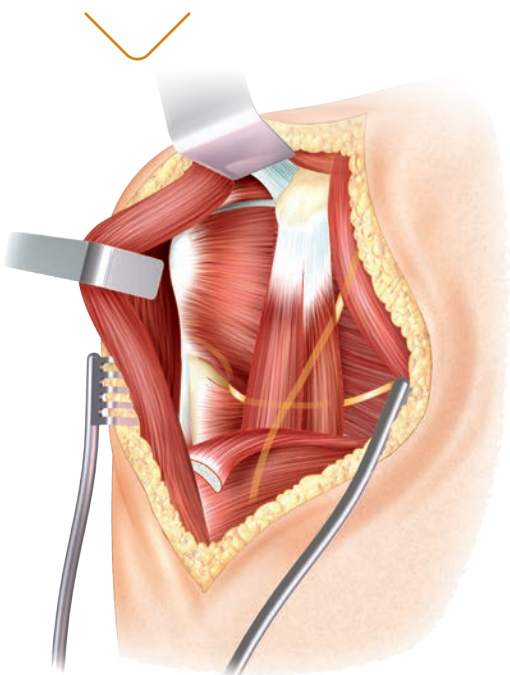

- e. Ligate the anterior circumflex vessels.

Identify the rotator interval.

The subscapular incision can be made in three ways:

- by sectioning the subscapularis muscle at the musculotendinous junction and sectioning the articular capsule at the same point,
- if there is limited preoperative external rotation, by detaching the subscapularis tendon subperiosteally starting from the bicipital groove (identified by the long head of the biceps at the superior border of the pectoralis major),
- by osteotomy of the lesser tuberosity to reduce the risk of secondary atrophy of the subscapularis.

In pathological conditions of the long head of the biceps:

- either a tenodesis is performed in the bicipital groove,
- or a tenotomy.

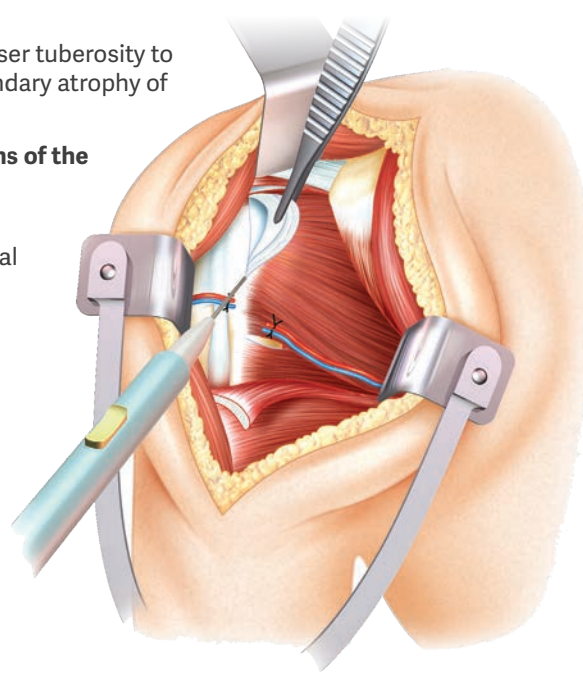

- f. Dislocate the humeral head in abduction and external rotation with retro-pulsion of the arm.

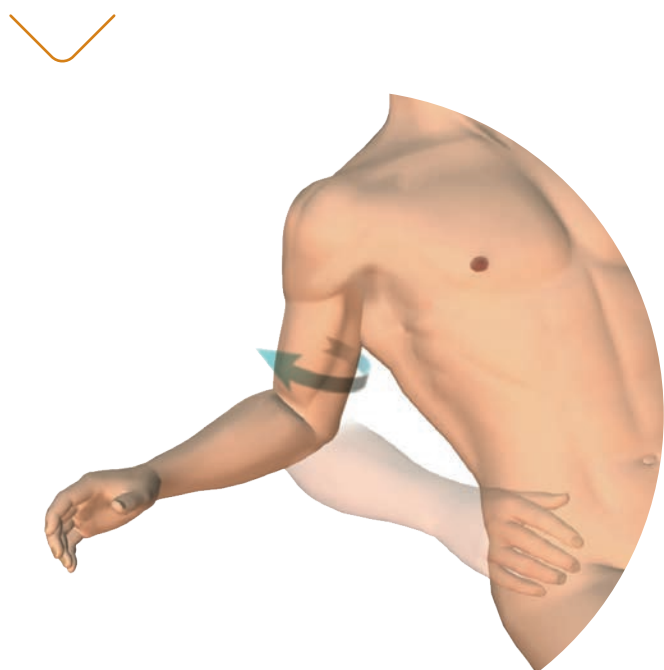

- g. Dislocation is only possible if the anterior-inferior capsule and the coracohumeral ligament have been sectioned. Osteophytes on the anatomical neck of the humerus are resected using bone forceps.

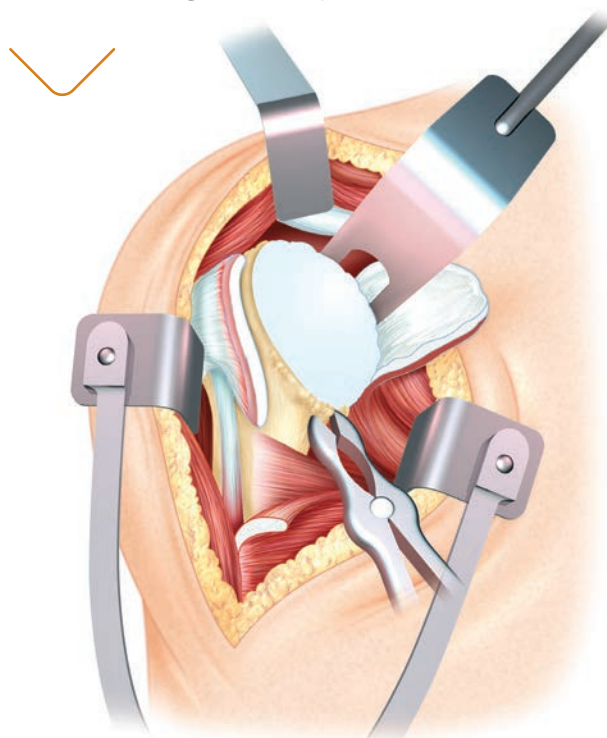

4. Humeral preparation

The entry point for the square-point awl is at the junction between the summit of the humeral head cartilage and the greater tuberosity, about 1 cm posteriorly and medially to the bicipital groove.

If the cortical bone is thick the $\varnothing 6$ reamer is recommended.

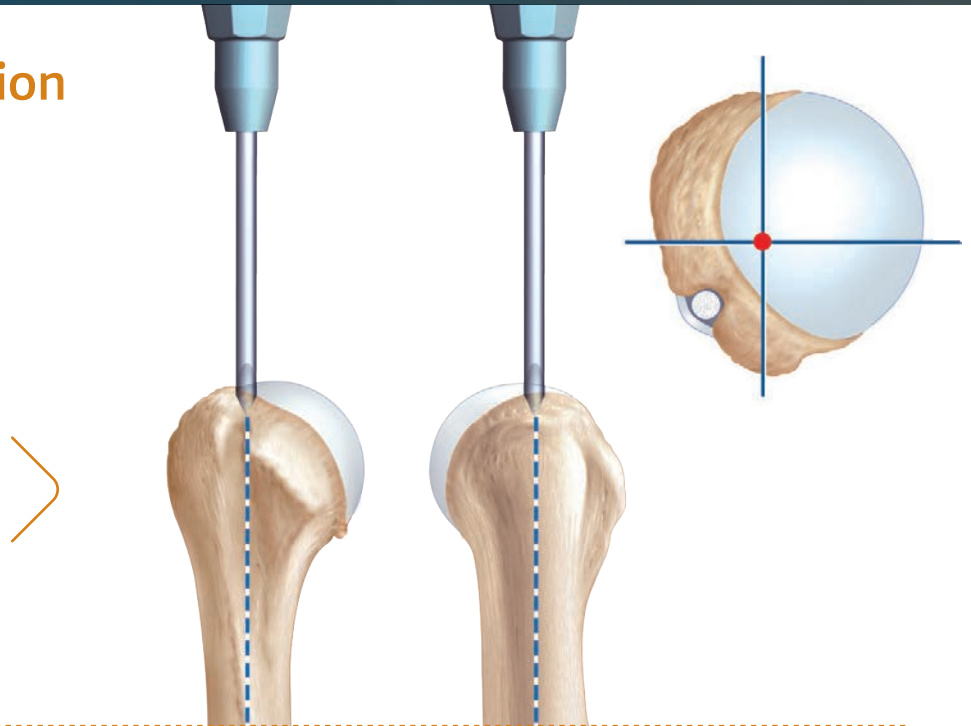

The length of the diaphyseal reamer allows the humeral stem to be aligned along the diaphyseal axis of the humerus and the risk of varus/valgus malpositioning to be reduced.



Perform diaphyseal reaming manually using increasing sizes of reamer ($\varnothing 6, 8, 10, 12, 14, 16$) until there is a sensation of reaming into the cortex.



4.1. Use of the cutting guide

Assembly the cutting guide and the deltopectoral approach cutting block or the superior-lateral approach with the cutting guide screws. The guide can be used on the right or left side, for both deltopectoral or superior lateral approach. The deltopectoral cutting block is positioned on the guide so that the side is visible.

Having fixed the axis of the guide, gradually externally rotate the arm until the forearm is in line with the screwed retroversion shaft producing the angle chosen (0°, 10°, 20°, 30°, 40°). A retroversion of 10 to 20° is recommended for the inverted prosthesis.

Put the humeral cutting guide onto the diaphyseal reamer.

The top of the cut starts systematically at the summit of the head of the humerus, at the junction between the humeral head cartilage and the greater tuberosity. The depth of resection of the head of the humerus is sufficiently deep if the medial part of the cut bone ends at the bottom of the glenoid cavity.

The angulation of 135° is fixed. If needed, a recut is possible 5 mm below the previous one.



Superior-lateral approach cutting guide

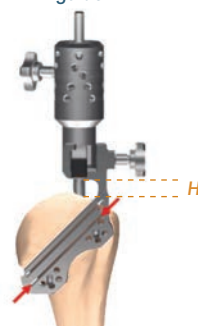

Deltopectoral approach cutting guide (use the maximal thickness of blade)

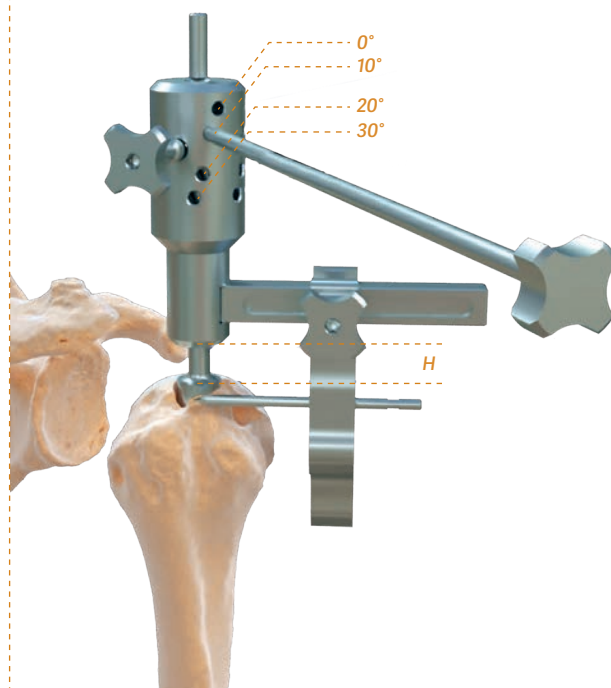

When the depth of cut and degree of retroversion have been defined, fix the humeral cutting block with a maximum of 4 pins in the metaphysis by using the clamp.



The diaphyseal reamer is then removed.

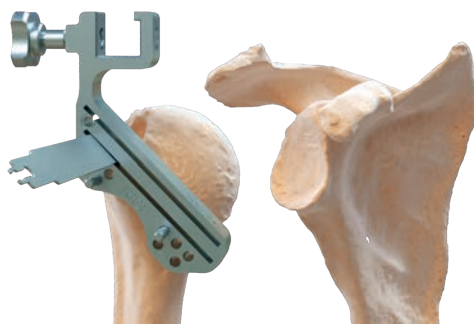

Cut the head of the humerus using an oscillating saw along the groove in the humeral cutting block with a fixed angle of 135° and the selected retroversion.



4.2. Humeral stem trials

Reproduce the retroversion by aligning the forearm with the retroversion shaft, fixed on the metaphyseal rasp handle. It is identical to that produced on the cutting guide.

The metaphysis is progressively prepared manually using increasing sizes of trial metaphyseal rasps.

The orientation of the metaphyseal ridges of the rasp compacts the cancellous bone and provides optimal stability for the implant.



Put the stem protector to protect the bone cutting surface during glenoid preparation.

5. Glenoid preparation

Dislocate the upper end of the humerus downwards and backwards.

Exposure of the glenoid requires 4 retractors:

- a retractor in front,
- a retractor below, at 6 o'clock,
- a retractor posteriorly, at 8 o'clock (pushing back the humerus protected by the metaphyseal rasp),
- a retractor, protecting the anterior fascicle of the deltoid.

Capsulectomy and circumferential excision of the labrum (360°) helps to expose and delimit the glenoid.

The central glenoid hole is marked with the square-pointawl, using the most suitable glenoid template.

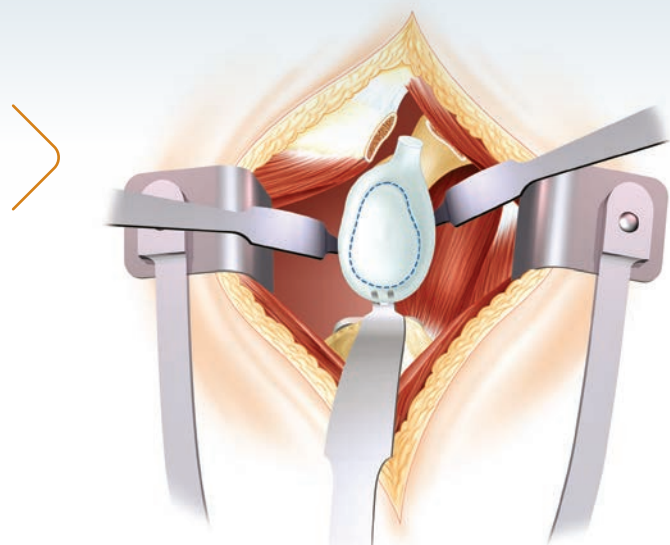

5.1. Positionnement de la broche guide

1 Measurements on a preoperative CT-scan

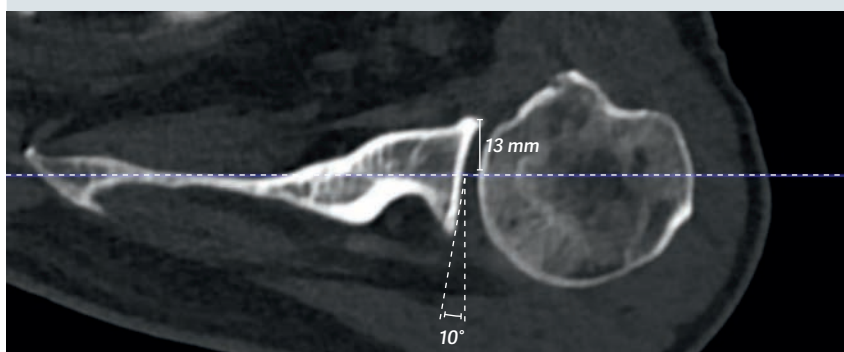

Guide choice:

- between 0°, 10° and 20° post compensation
- Left or right

Distance on the guide

2 E.g. use of left 10° guide

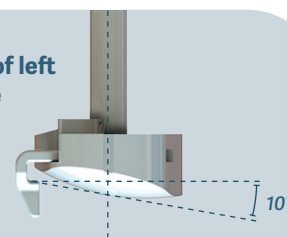

3 Length adjustment

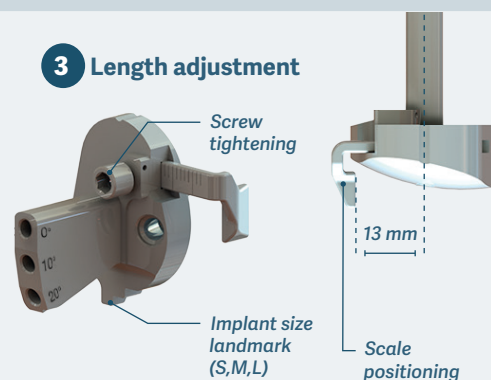

4 Tilt choice



Without superior erosion, we recommend 0 or 10° tilt.

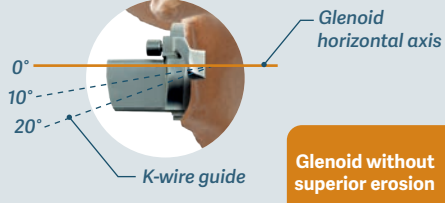

Glenoid without superior erosion

If the glenoid has a 10° superior erosion, the tilt must be chosen at:
 - 10° to have a tilt of 0°
 - 20° to have a tilt of 10°

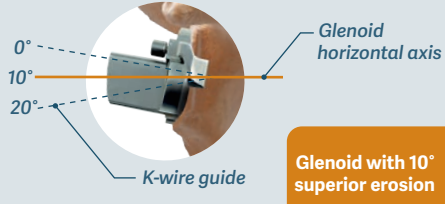

Glenoid with 10° superior erosion

5

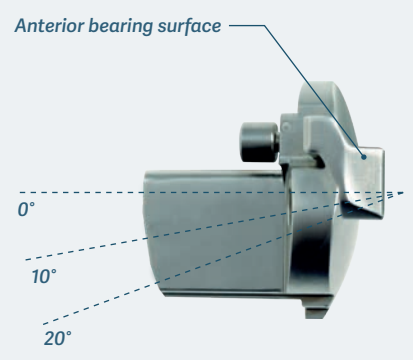

e-ORTHO pre-operative templating

15 mm

13 mm

Entry Point
Ant 15mm
Inf 13mm

Glenoid planning
Reaming depth
Central 3mm
Max 7mm

Inclination	Relative	Seating	58%
Version	19° Sup 7° Retro	Implant	3° Inf 3° Retro
		Correction	20° Inf 10° Ante

e-ORTHO

5.2. Glenoid bone preparation

Insert the guide pin into the glenoid reamer handle.

Openwork glenoid reamer (XS/S-M-L) is used to abrade the glenoid cavity while retaining the subchondral bone.

These are assembly on the glenoid reamer handle to be power-driven or manually used with the handle (in option).

Initiate reamer a few millimeters off the bone to avoid risk of fracture.

Burring creates a concave surface which is congruent with the convex base of the glenoid implant. (cemented glenoid or metal-back glenoid plate).

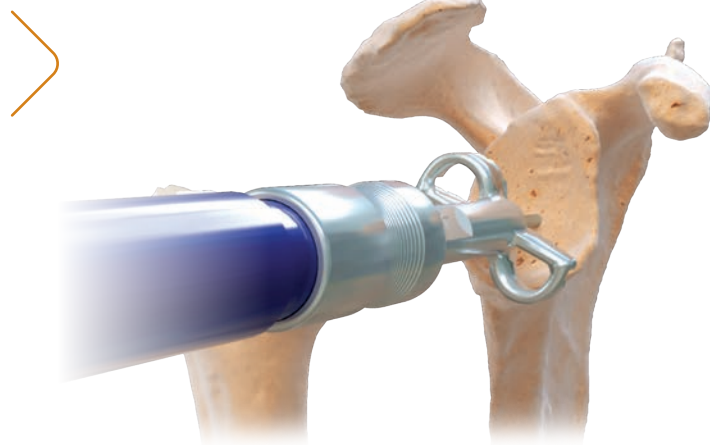

Excision of the bony edge is sometimes necessary using bone forceps or the large reamer.

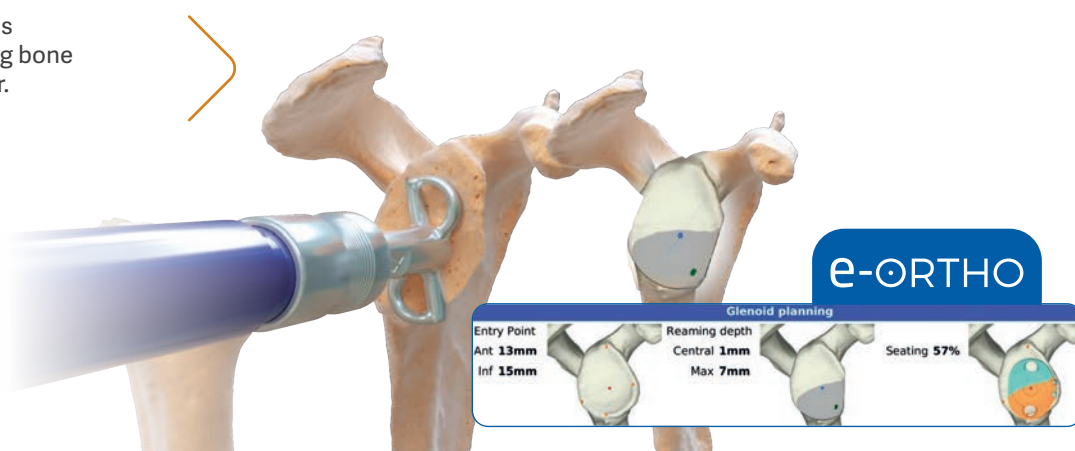

5.3. Bone preparation for metal-back

Place the glenoid template aligned with cardinal points of the glenoid. Then drill the first hole with the $\varnothing 5$ mm stopped drill bit.

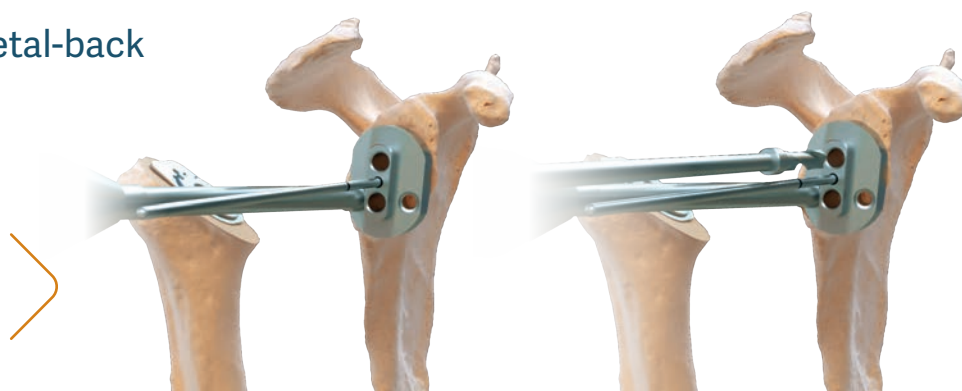

Put the fixing pin to stabilise and drill the second hole.

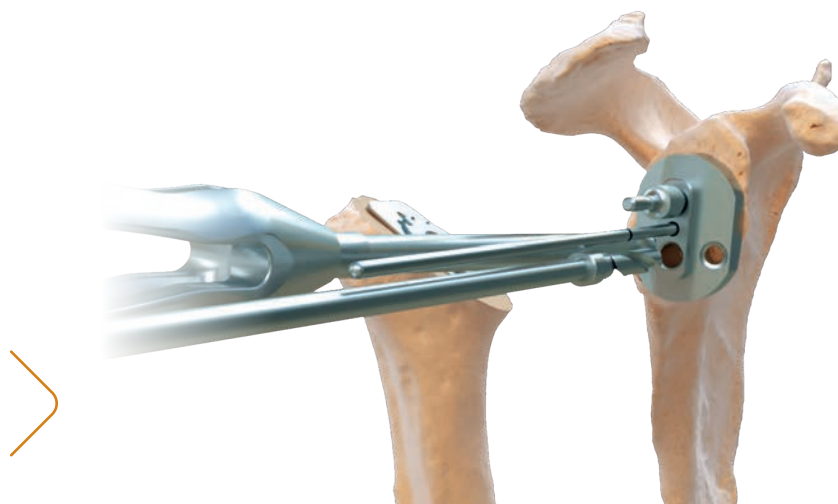

Use an oscillating saw to achieve an economical cut to accommodate the baseplate lateral winglet. Use the edge of the punch shield as a cutting surface.



Remove the keel drill guide and use the cannulated tapered reamer to complete the central hole.

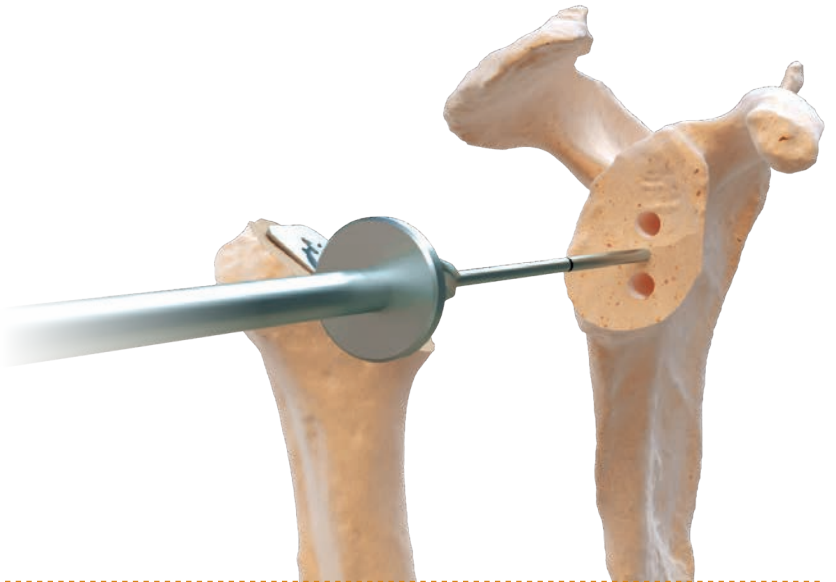

For a metal back long peg (LP), drill with the long cannulated drill bit.

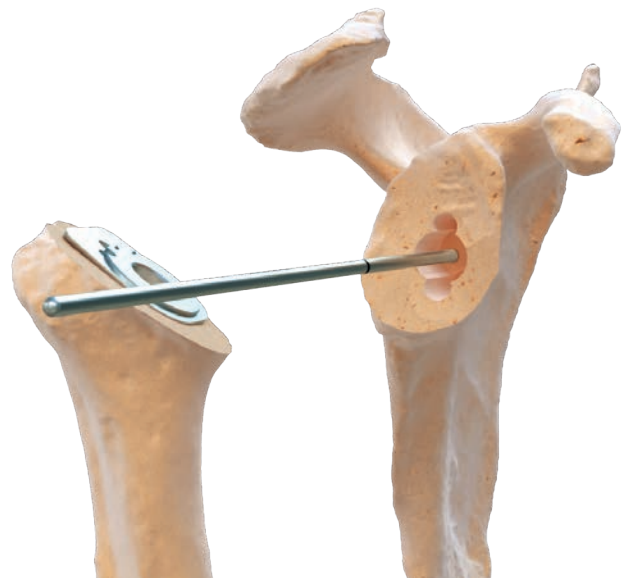

Option

Put in place trial metal back with the M5 handle. Verify primary stability and metal-back sitting on the glenoid surface.

5.4. Definitive metal-back glenoid plate

e-ORTHO

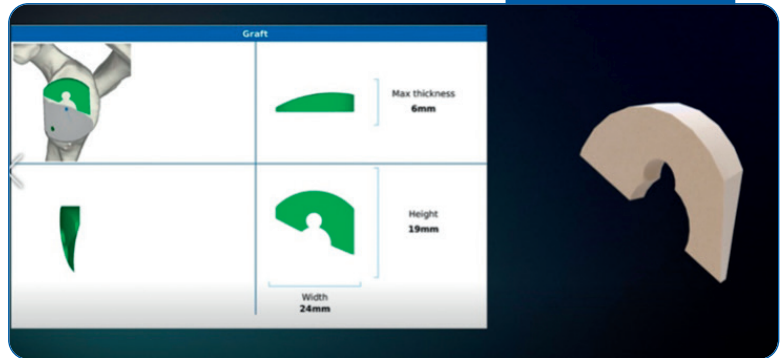

Availability to place a bone graft (e-ORTHO templating).

Impact the definitive metal-back glenoid base using the baseplate positioner/impactor.

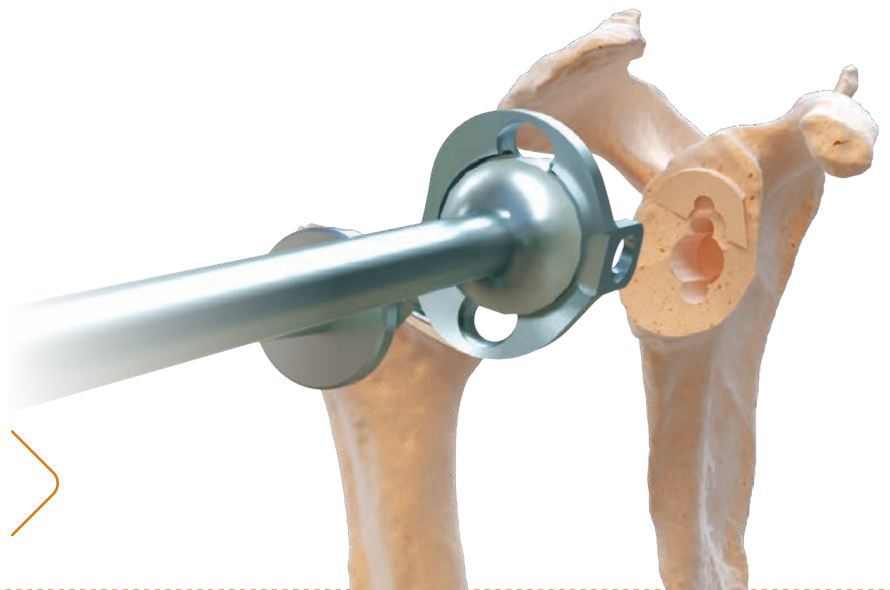

Axial screws orientation

Drill the superior and inferior holes with the Ø3,2 mm drill bit and screw sleeve. The best bone fixation areas can be sought because of tolerance of 10°.

The upper screw aims for the base of the coracoid and the lower screw aims for the pillar of the scapula.

e-ORTHO

Upper screw

Direction **Anterior**



e-ORTHO

Lower screw

Direction **Anterior**



- Read screw measurement on the graduation marks of the $\varnothing 3,2$ drill bit or by positioning the depth gauge or reproducing e-ORTHO templating.
- Screw cancellous screws $\varnothing 5,5$ by using the 6 sides screwdriver.

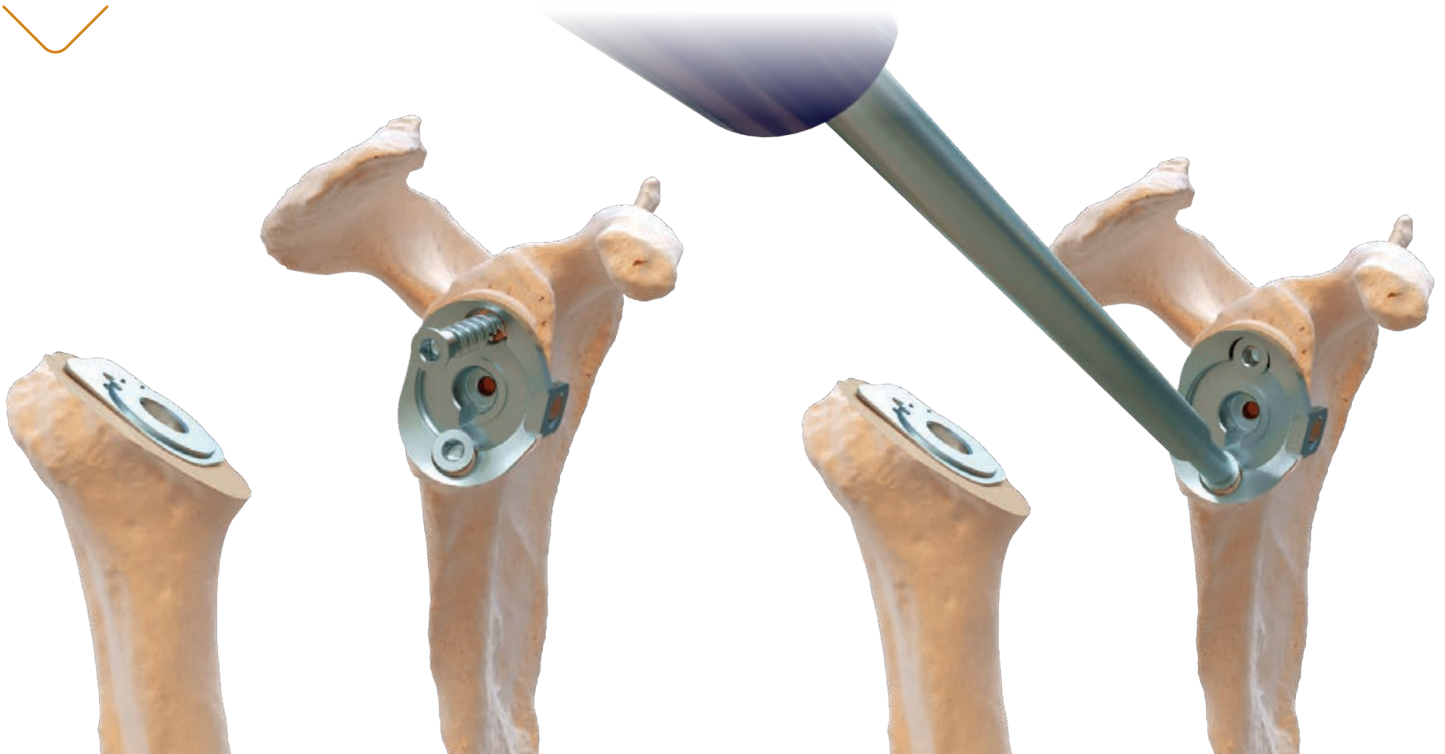

Option: fitting the anterior-posterior screw (optional)

This procedure is recommended for a bone graft or anterior glenoid fracture. A deltopectoral approach makes it easier. In the case of a superior-lateral approach, it could be done transcutaneously.

- Put the anterior-posterior guide for the metal-back glenoid base in place using the anterior-posterior guide handle.
- Put the screw and drill sleeves into the metal-back glenoid base sight. Drill with $\varnothing 3,2$ mm drill bit. The length of the screw can't be read with this drill bit.
- Remove the drill sleeve and the drill bit, insert the depth gauge and measure the length of the screw ("cortical" writing front).
- Insert and drill the cortical screw $\varnothing 4,5$ with the 6 sides screwdriver.

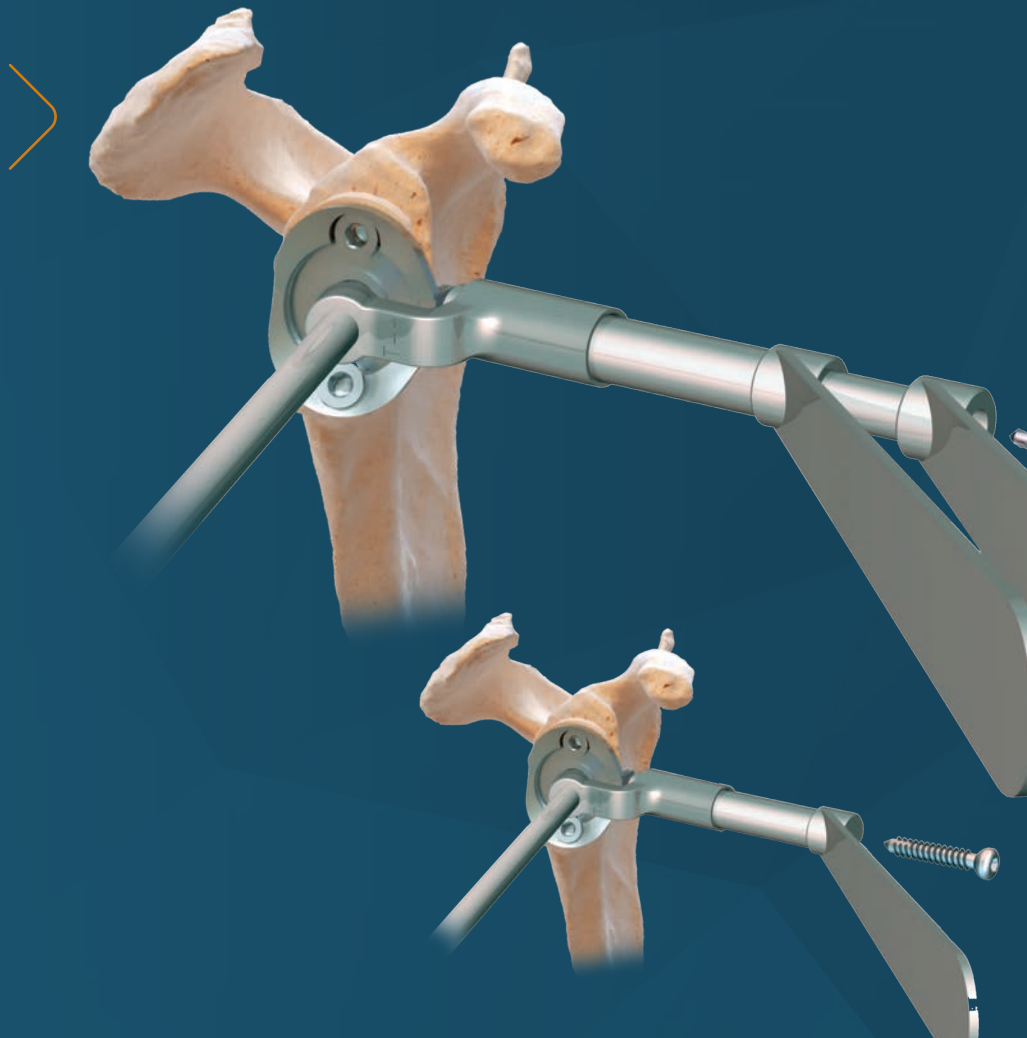

6. Full trail test

6.1. Trial glenosphere (optional)

Remove the screw from the trial glenosphere. Put the trial glenosphere in place with the glenosphere handle.

Fix the trial glenosphere to the definitive metal-back glenoid base using the screw.

Glenosphere and metal-back glenoid base plate compatibility:

Glenosphere size	Ø36	Ø39	Ø42
Metal-back base plate size (standard or -LP)	XS or S	XS, S or M	M or L



Fully respect the compatibility table.

Underestimation of the glenosphere diameter may lead to metal-back base plate and humeral insert conflicts.

6.2. Trial humeral insert

Impact the trial humeral insert (standard or off-centered) onto the trial rasp with the impaction handle and humeral insert impaction piece.

The humeral insert and glenosphere must have the same diameter.

If there is any decoaptation, glenoid conflict (posterior, anterior, inferior) must be investigated.

7. Definitive implants

7.1. Glenosphere

Attach the glenosphere to the glenosphere positioner/impactor.

Twist the top handle of the positioner clockwise relative to the bottom handle to firmly connect to glenosphere.

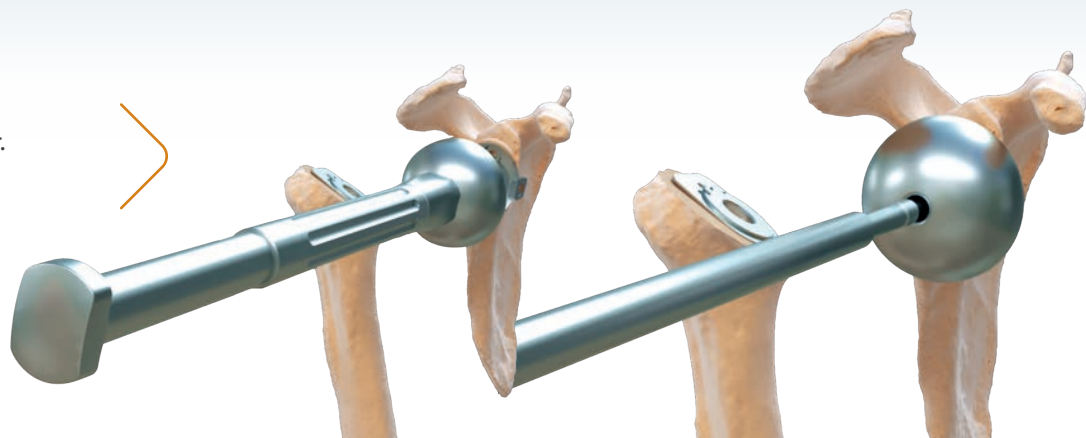

7.2. Humeral stem

Grafts of cancellous bone taken from the resected head of the humerus are put into the (inferior and anterior) metaphyseal region to ensure optimal stability for the definitive humeral stem.

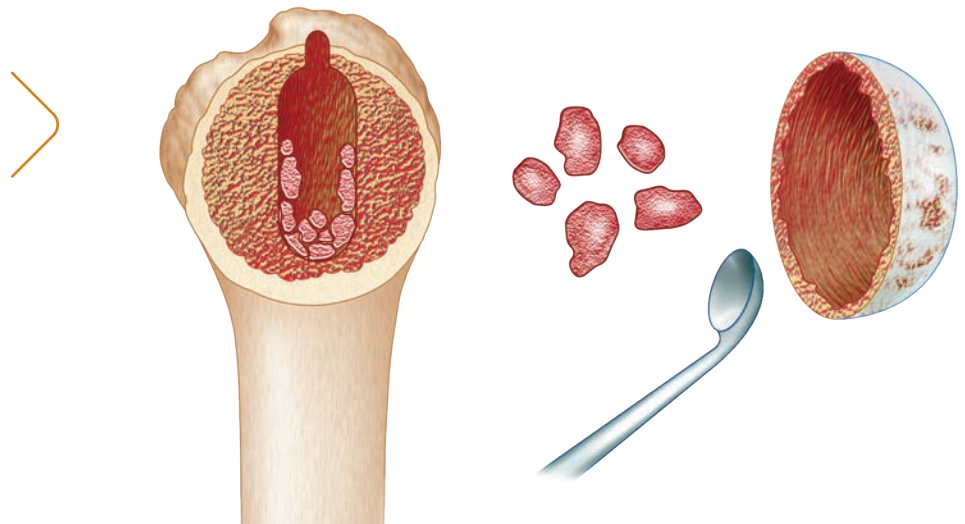

Guide the retroversion using the shaft attached to the rasp handle aligned in the axis of the forearm.

Impact the humeral stem with or without cement in the smooth diaphyseal region, until the plate arrives in contact with the cut bone of the humerus.

Cemented stem is cementable on its complete surface: metaphysis and diaphysis

Cement the diaphyseal part of the humeral stem if the bone is osteoporotic or press-fit the humeral prosthesis without cement with shavings of metaphyseal cancellous bone.

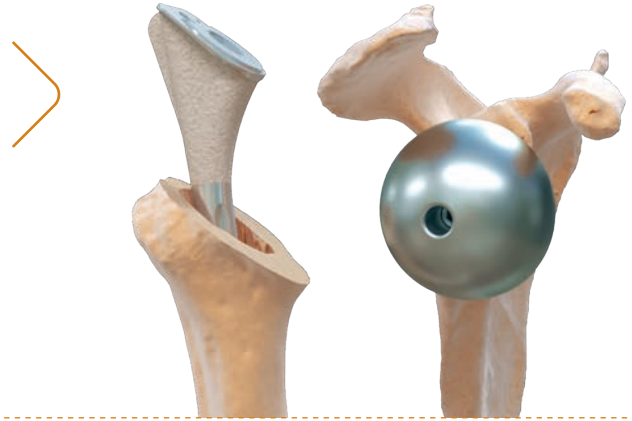

7.3. Humeral insert

Humeral insert is inclined at 155° and hollowed medially to avoid glenoid notching.

The cup is held in place by impacting the morse cone and its under-surface locking into the shape of the humeral plate (complementary surfaces).

Impact the humeral insert by using the impaction handle and humeral insert impaction piece.

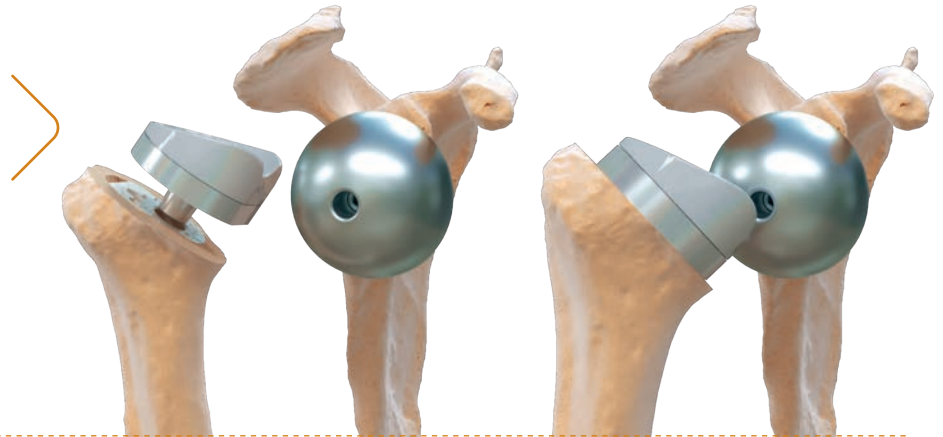

7.4. Full test

Reduce the joint: movement must not be restricted (gleno-humeral mobility 0° - 70° without moving the scapula).

Test elbow to body rotation and abduction to 90°.

Slight laxity between the glenosphere and the humeral cup is nevertheless desirable.

Difficulty in reducing the trial prosthesis or too much "tension" in the implant will limit active post-operative mobility and means that the humerus should be recut.

Reduce the prosthesis by adducting the arm.

Check the stability of the prosthesis in abduction.

External and internal rotation: check that there is no internal or posterior conflict during adduction of the arm and ER1.



8. Instrumentation

8.1. Universal humerus



- | | | | |
|---|-----------------|--|--------------|
| 1. ARROW Cutting guide..... | ref. 267 610 | 17. ARROW Protector for metaphysis | ref. 261 845 |
| 2. ARROW II Superior-lateral approach cutting guide | ref. 269 886 | 18. ARROW II Broach handle | ref. 267 614 |
| 3. ARROW II Cutting guide connecting screw..... | ref. 269 887 | 19. ARROW Head extractor..... | ref. 261 014 |
| 4. ARROW II Deltpectoral approach cutting guide..... | ref. 269 885 | 20. ARROW Trial rasp D6 L100..... | ref. 267 615 |
| 5. ARROW Reamer holder..... | ref. 261 054 | 21. ARROW Trial rasp D8 L120..... | ref. 267 616 |
| 6. ARROW Drill D6..... | ref. 261 010 | 22. ARROW Trial rasp D10 L125 | ref. 267 617 |
| 7. ARROW Cutting guide pins | ref. 264 460 | 23. ARROW Trial rasp D12 L130 | ref. 267 618 |
| | or ref. 261 056 | 24. ARROW Trial rasp D14 L135 | ref. 267 619 |
| 8. FHK Magnetic holder AO (optional)
(for 269 888) (OPTIONAL) | ref. 269 348 | 25. ARROW Impactor Handle | ref. 264 459 |
| 9. ARROW AO pin driver (for 268 016) (OPTIONAL) | ref. 269 239 | 26. ARROW II Standard humeral trial insert D36 H00..... | ref. 267 678 |
| 10. ARROW Retroversion rod..... | ref. 261 053 | 27. ARROW II Standard humeral trial insert D36 H05..... | ref. 267 679 |
| 11. ARROW Pin extractor | ref. 264 461 | 28. ARROW II Standard humeral trial insert D36 H10..... | ref. 267 680 |
| | or ref. 261 831 | 29. ARROW II Standard humeral trial insert D39 H00..... | ref. 267 681 |
| 12. ARROW Reamer D6..... | ref. 267 604 | 30. ARROW II Standard humeral trial insert D39 H05..... | ref. 267 682 |
| | or ref. 266 221 | 31. ARROW II Standard humeral trial insert D39 H10..... | ref. 267 683 |
| 13. ARROW Reamer D8..... | ref. 267 605 | 32. ARROW II Off-centered humeral trial insert D36 H00..... | ref. 267 687 |
| | or ref. 261 048 | 33. ARROW II Off-centered humeral trial insert D36 H05..... | ref. 267 688 |
| 14. ARROW Reamer D10..... | ref. 267 606 | 34. ARROW II Off-centered humeral trial insert D36 H10 | ref. 267 689 |
| | or ref. 261 049 | 35. ARROW II Off-centered humeral trial insert D39 H00..... | ref. 267 690 |
| 15. ARROW Reamer D12..... | ref. 267 607 | 36. ARROW II Off-centered humeral trial insert D39 H05..... | ref. 267 691 |
| | or ref. 261 050 | 37. ARROW II Off-centered humeral trial insert D39 H10 | ref. 267 692 |
| 16. ARROW Reamer D14..... | ref. 267 608 | | |
| | or ref. 261 051 | | |

8.2. Universal glenoid

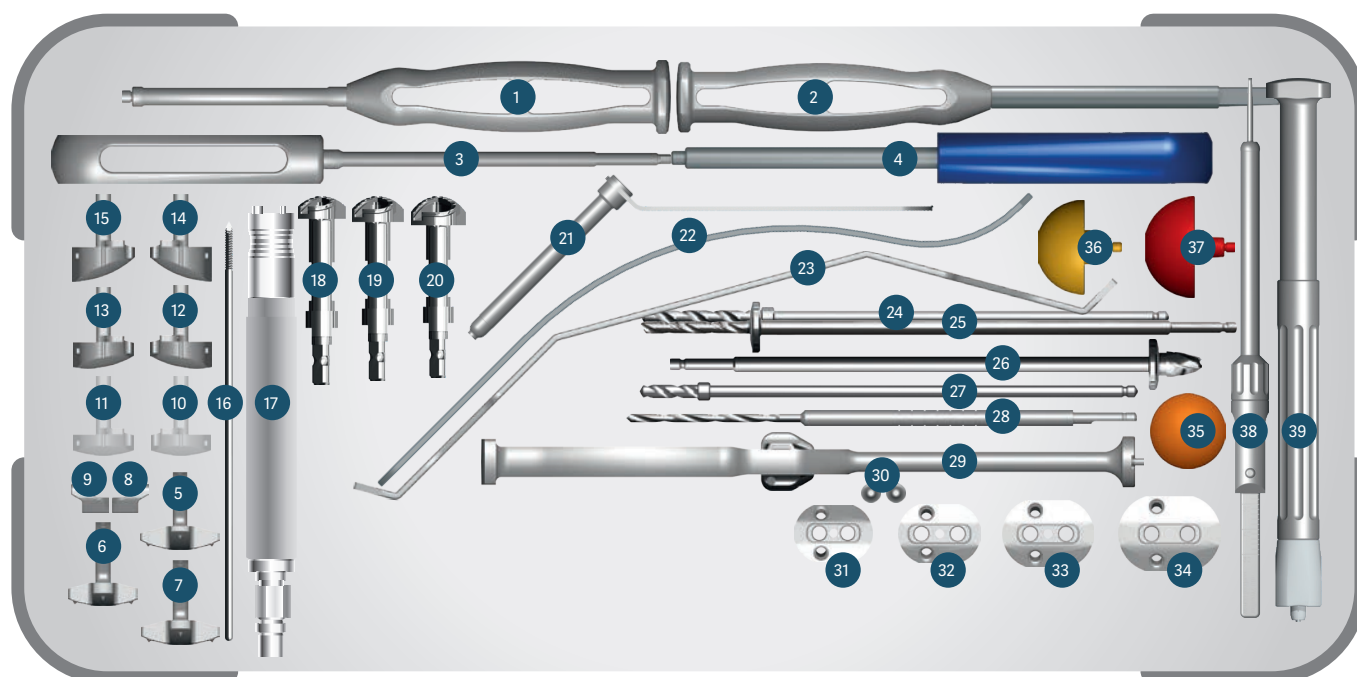

- | | | | |
|--|-----------------|---|--------------|
| 1. ARROW II Trial MB handle..... | ref. 267 667 | 20. ARROW Cannulated reamer L..... | ref. 267 652 |
| 2. ARROW chisel..... | or ref. 261 095 | 21. ARROW Barrel for drill..... | ref. 264 479 |
| 3. ARROW Screwdriver D3,5..... | ref. 270 827 | 22. ARROW Retractor..... | ref. 261 059 |
| 4. ARROW Handle for antero-posterior screw..... | or ref. 261 100 | 23. ARROW II Glenoid posterior retractor..... | ref. 269 890 |
| 5. ARROW II PTX Glenoid guide S44/S (WOS)..... | ref. 261 844 | 24. ARROW Stopped drill bit D5 for rev. glen. base..... | ref. 264 102 |
| 6. ARROW II PTX Glenoid guide S46/M (WOS)..... | ref. 269 892 | 25. ARROW Cannulated stop drill D5 long peg..... | ref. 267 649 |
| 7. ARROW II PTX Glenoid guide S48/L (WOS)..... | ref. 269 893 | 26. ARROW II Metal-back central peg drill bit..... | ref. 267 662 |
| 8. ARROW Glenoid guide stylus - right..... | ref. 269 894 | 27. ARROW Drill with end stop D5..... | ref. 261 069 |
| 9. ARROW Glenoid guide stylus - left..... | ref. 269 092 | 28. ARROW V7 Dia 3,2mm drill..... | ref. 264 472 |
| 10. ARROW Glenoid guide 0° post wear - right..... | ref. 269 093 | 29. ARROW II Glenoid base-plate impactor..... | ref. 267 674 |
| 11. ARROW Glenoid guide 0° post wear - left..... | ref. 269 086 | 30. ARROW Drilling guide fixing pins..... | ref. 261 058 |
| 12. ARROW Glenoid guide 10° post wear - right..... | or ref. 267 112 | 31. ARROW II Metal-back guide XS..... | ref. 267 663 |
| 13. ARROW Glenoid guide 10° post wear - left..... | ref. 269 087 | 32. ARROW II Metal-back guide S..... | ref. 267 664 |
| 14. ARROW Glenoid guide 20° post wear - right..... | ref. 269 088 | 33. ARROW II Metal-back guide M..... | ref. 267 665 |
| 15. ARROW Glenoid guide 20° post wear - left..... | ref. 269 089 | 34. ARROW II Metal-back guide L..... | ref. 267 666 |
| 16. ARROW Guide pin D3 L170 (OPTIONAL)..... | ref. 269 090 | 35. ARROW II Humeral insert impactor tip..... | ref. 267 696 |
| 17. ARROW Reamer handle AO Stryker Zier.Hall..... | ref. 265 423 | 36. ARROW II Glensphere trial D36..... | ref. 267 697 |
| or Glenoid reamer handle - Zier Hall - ZH..... | ref. 269 147 | 37. ARROW II Glensphere trial D39..... | ref. 267 698 |
| 18. ARROW Cannulated reamer XS-S..... | ref. 265 414 | 38. ARROW Depth gauge..... | ref. 269 241 |
| 19. ARROW Cannulated reamer M..... | ref. 267 651 | 39. ARROW Glensphere positioner/impactor..... | ref. 269 137 |

8.3. Universal anatomical

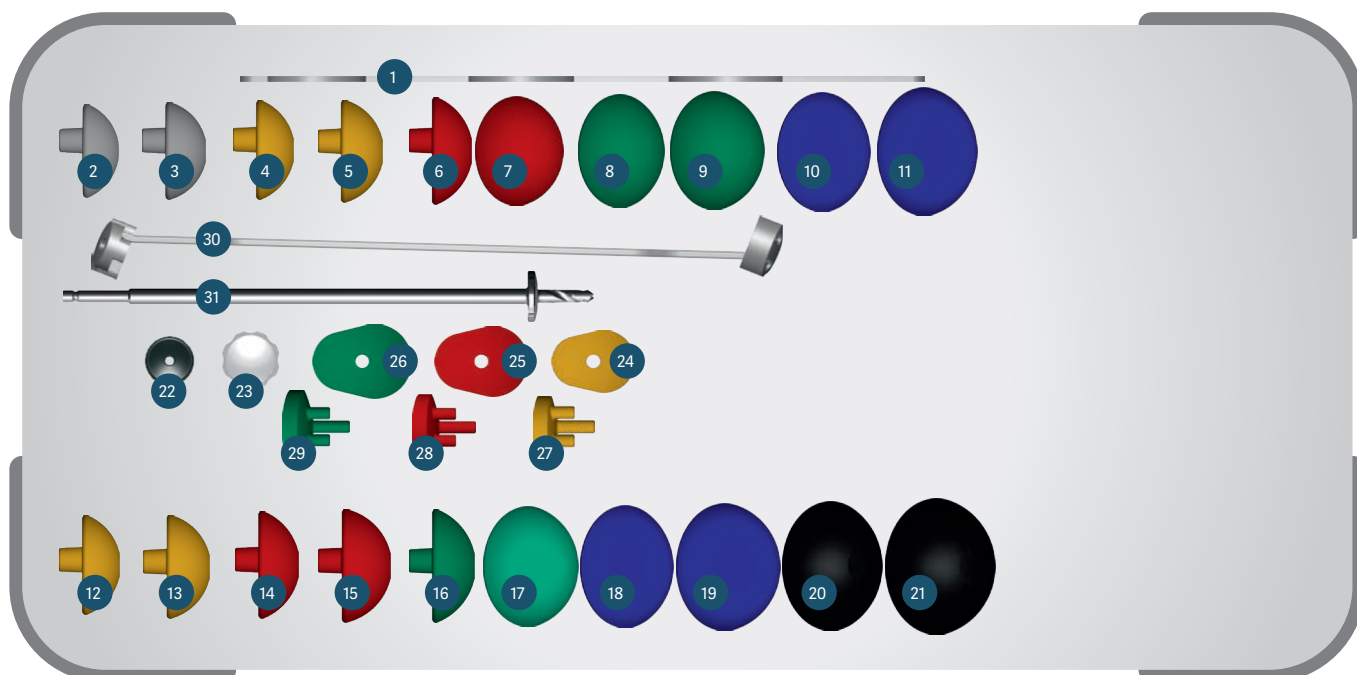

- | | |
|---|---|
| 1. ARROW II Humeral head sizer.....ref. 267 621 | 20. ARROW II Trial humeral head offset D54 H19 offset (+2).....ref. 267 630 |
| 2. ARROW II Trial humeral head offset D39 H14 offset (+4).....ref. 267 632 | 21. ARROW II Trial humeral head offset D54 H23 offset (+2).....ref. 267 631 |
| 3. ARROW II Trial humeral head offset D39 H16 offset (+4).....ref. 267 633 | 22. ARROW Head impactor tip.....ref. 261 043 |
| 4. ARROW II Trial humeral head offset D42 H15 offset (+4).....ref. 267 634 | 23. ARROW PE Glenoid impaction tip.....ref. 267 659 |
| 5. ARROW II Trial humeral head offset D42 H17 offset (+4).....ref. 267 635 | or ref. 261 081 |
| 6. ARROW II Trial humeral head offset D45 H16 offset (+4).....ref. 267 636 | 24. ARROW II Glenoid template XS-S.....ref. 267 644 |
| 7. ARROW II Trial humeral head offset D45 H19 offset (+4).....ref. 267 637 | or ref. 261 077 |
| 8. ARROW II Trial humeral head offset D48 H17 offset (+4).....ref. 267 638 | 25. ARROW II Glenoid template M.....ref. 267 645 |
| 9. ARROW II Trial humeral head offset D48 H20 offset (+4).....ref. 267 639 | or ref. 261 078 |
| 10. ARROW II Trial humeral head offset D51 H18 offset (+4).....ref. 267 640 | 26. ARROW II Glenoid template L.....ref. 267 646 |
| 11. ARROW II Trial humeral head offset D51 H22 offset (+4).....ref. 267 641 | or ref. 261 079 |
| 12. ARROW II Trial humeral head offset D42 H15 offset (+2).....ref. 267 622 | 27. ARROW II C/M trial glenoid S.....ref. 267 655 |
| 13. ARROW II Trial humeral head offset D42 H17 offset (+2).....ref. 267 623 | or ref. 261 070 |
| 14. ARROW II Trial humeral head offset D45 H16 offset (+2).....ref. 267 624 | 28. ARROW II C/M trial glenoid M.....ref. 267 656 |
| 15. ARROW II Trial humeral head offset D45 H19 offset (+2).....ref. 267 625 | or ref. 261 071 |
| 16. ARROW II Trial humeral head offset D48 H17 offset (+2).....ref. 267 626 | 29. ARROW II C/M trial glenoid L.....ref. 267 657 |
| 17. ARROW II Trial humeral head offset D48 H20 offset (+2).....ref. 267 627 | or ref. 261 072 |
| 18. ARROW II Trial humeral head offset D51 H18 offset (+2).....ref. 267 628 | 30. ARROW II Full PE drilling guide.....ref. 267 654 |
| 19. ARROW II Trial humeral head offset D51 H22 offset (+2).....ref. 267 629 | 31. ARROW Cannulated stop drill D5.....ref. 267 648 |

8.4. Option universal revision

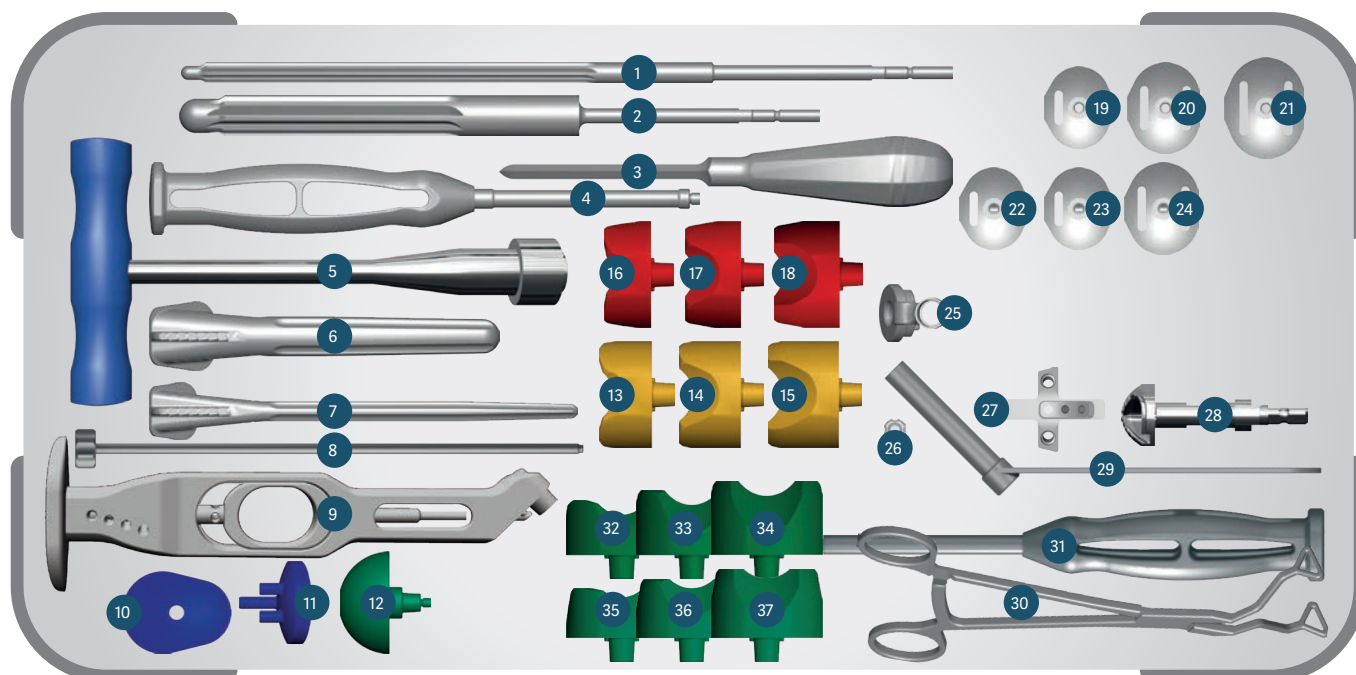

- | | | | |
|--|-----------------|--|-----------------|
| 1. ARROW Reamer D8 L200..... | ref. 268 108 | 18. ARROW* Standard humeral trial insert D39 H10..... | ref. 257 318 |
| 2. ARROW Reamer D16 L140..... | or ref. 257 333 | | or ref. 264 500 |
| 3. Square awl..... | ref. 264 868 | 19. ARROW II Trial MB glenoid base-plate S..... | ref. 267 668 |
| 4. ARROW II Trial MB handle..... | ref. 267 667 | 20. ARROW II Trial MB glenoid base-plate SC M..... | ref. 267 669 |
| 5. ARROW T handle long..... | ref. 261 076 | 21. ARROW II Trial MB glenoid base-plate SC L..... | ref. 267 670 |
| 6. ARROW II Trial rasp D16 L140..... | ref. 267 620 | 22. ARROW II Trial MB glenoid base-plate SC XS Long..... | ref. 267 671 |
| 7. ARROW II Trial rasp D8 L170..... | ref. 268 109 | 23. ARROW II Trial MB glenoid base-plate SC S Long..... | ref. 267 672 |
| 8. ARROW Retroversion rod..... | ref. 261 053 | 24. ARROW II Trial MB glenoid base-plate SC M Long..... | ref. 267 673 |
| 9. ARROW II Broach handle..... | ref. 267 614 | 25. ARROW II AP screw drilling guide..... | ref. 267 675 |
| 10. ARROW II Glenoid template XL..... | ref. 267 647 | 26. ARROW V7 Connecting screw for lateral guide..... | ref. 264 478 |
| 11. ARROW II C/M Trial glenoid XL..... | ref. 267 658 | 27. ARROW II PTX glenoid guide S50/XL (WOS)..... | ref. 269 895 |
| 12. ARROW II Trial glenosphere D42..... | ref. 267 699 | 28. ARROW Cannulated reamer XL..... | ref. 267 653 |
| 13. ARROW* Standard humeral trial insert D36 H00..... | ref. 261 096 | 29. ARROW Barrel for screw..... | ref. 261 846 |
| | or ref. 264 495 | 30. ARROW Glenoid inserter..... | ref. 267 110 |
| 14. ARROW* Standard humeral trial insert D36 H05..... | ref. 261 097 | 31. ARROW Glenosphere positioner/impactor..... | ref. 261 101 |
| | or ref. 264 496 | 32. ARROW II Standard humeral trial insert D42 H00..... | ref. 267 684 |
| 15. ARROW* Standard humeral trial insert D36 H10..... | ref. 257 317 | 33. ARROW II Standard humeral trial insert D42 H05..... | ref. 267 685 |
| | or ref. 264 497 | 34. ARROW II Standard humeral trial insert D42 H10..... | ref. 267 686 |
| 16. ARROW* Standard humeral trial insert D39 H00..... | ref. 261 098 | 35. ARROW II Off-centered humeral trial insert D42 H00..... | ref. 267 693 |
| | or ref. 264 498 | 36. ARROW II Off-centered humeral trial insert D42 H05..... | ref. 267 694 |
| 17. ARROW* Standard humeral trial insert D39 H05..... | ref. 261 099 | 37. ARROW II Off-centered humeral trial insert D42 H10..... | ref. 267 695 |
| | or ref. 264 499 | | |

* Arrow I trial implants in case of revision



**DISTRIBUTEURS
DISTRIBUTORS**

FR, FH ORTHO SAS
3 rue de la Forêt - Zone Industrielle
BP 50009
68990 Heimsbrunn CEDEX - FRANCE
Tél. +33 (0)3 89 81 90 92
Fax : +33 (0)3 89 81 80 11
info@fhortho.com
www.fhortho.com

USA, FH ORTHOPEDICS INC.
OrthoEx
7327 E Tierra Buena Lane
Scottsdale, Arizona 85260 - USA
Phone: +1 (412) 965-0950
customerservice@fhortho-us.com
www.fhortho.com

PL, FH ORTHO POLSKA
Ul. Garbary 95/A6,
61-757 Poznan - POLSKA
Phone: +48 61 863 81 27
Fax: +48 61 863 81 28
biuro@implants24.pl
www.fhortho.com



**FABRICANT
MANUFACTURER**

FR, FH INDUSTRIE
6 rue Nobel, Z.I. de Kernevez
29000 QUIMPER - FRANCE
Tél. +33 (0)2 98 55 68 95
Fax : +33 (0)2 98 53 42 13
contact-fhi@fhortho.com
www.fhortho.com