

T L S[®]

T a p e L o c k i n g S c r e w

Posterior Cruciate Ligament **SURGICAL TECHNIQUE**

All inside - Short Graft - ST4 (SINGLE BUNDLE RECONSTRUCTION)





Indications for Use:

The TLS® system is designed for the fixation of the grafts to the femur and tibia during orthopedic surgical procedures for Anterior Cruciate Ligament (ACL) and Posterior Cruciate Ligament (PCL) reconstructions.

TLS®
Tape Locking Screw

SURGICAL TECHNIQUE

PRE-OPERATIVE PLANNING (optional)

A lateral view X-ray of the knee in extension enables the physician to evaluate the distance between the desired fixation points. The length of the intra articular path of the transplant is then determined. Accordingly, the total length of the transplant corresponds to this measurement plus 10 mm for insertion into the femur and 15 mm for insertion into the tibia.

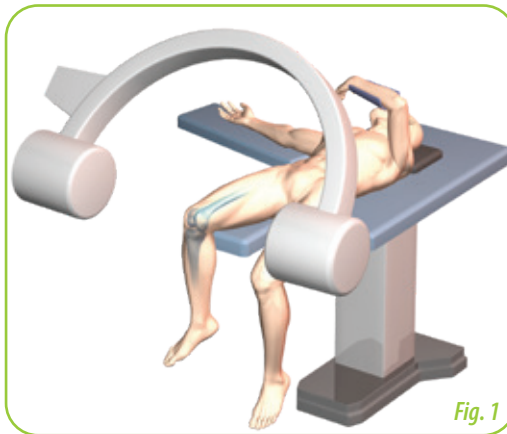

Fig. 1

POSITIONING OF THE PATIENT

Set up the X-RAY before disinfecting the patient to avoid any manipulation of the sterile barrier during the surgical procedure. (Fig. 1) The patient is in back decubitus, leg pending, knee at 90°. It is now possible to control preoperatively each step of the procedure under X-RAY.

GRAFT HARVESTING

Oblique incision (Fig. 2a-b)

The semi-tendinosus (ST) is the primary autograft source for use with the TLS system. An open-style tendon stripper is included in the standard TLS instrument set.

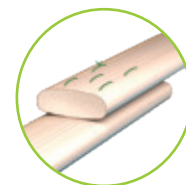

Fig. 2c

In most cases the transplant used is the semi-tendinosus (ST) but the gracilis can be used to extend the graft to the length required in case of ST harvesting troubles. (Fig. 2c)

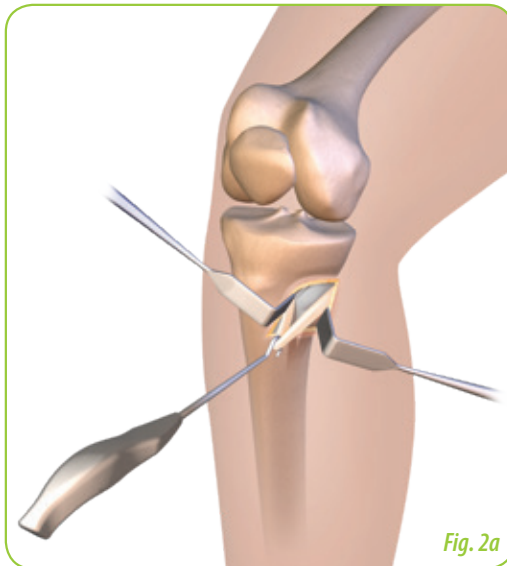

Fig. 2a

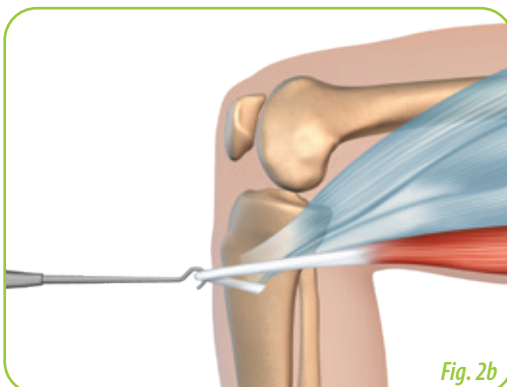

Fig. 2b



Harvesting hook



PREPARING THE GRAFT USING THE TLS WORKSTATION

Select the graft's length according to the height of the patient using the graft length table. Place the posts on the workstation accordingly. For graft Length higher than 60mm when using the T table please add a table extension titanium piece available in the PCL kit. This will ensure adequate graft size preparation. (Fig. 3)

A 4 strand loop is formed on the workstation (Fig. 4). According to reference papers graft diameter should be no smaller than 8mm to reduce revision rates.

This usually results in a construct with both loose ends near the same post. Please respect the picture below.

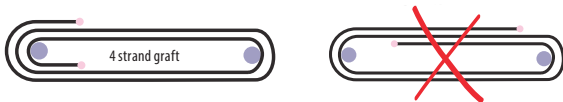

The first graft-formation suture is placed to secure the loose ends to the main strands on the thicker part of the graft (Tibia part), this will simulate the anatomy. Please respect the picture below.

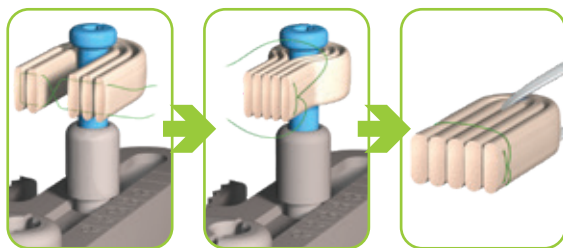

The 4 strands are joined together by a minimum of 3 cross stitches at both ends of the graft. 2-3 sutures are placed in the open end and 1-2 sutures are placed in the closed end.



Sutures placed at 10 & 15mm can be used to control arthroscopically the transplant penetration into the tibia and the femoral sockets respectively or simply use the suture marker.

Next, the posts are removed from the sizer and the tapes are pulled through the ends of the graft loops. The ends of the tapes are evened prior to placement on the tensioner.

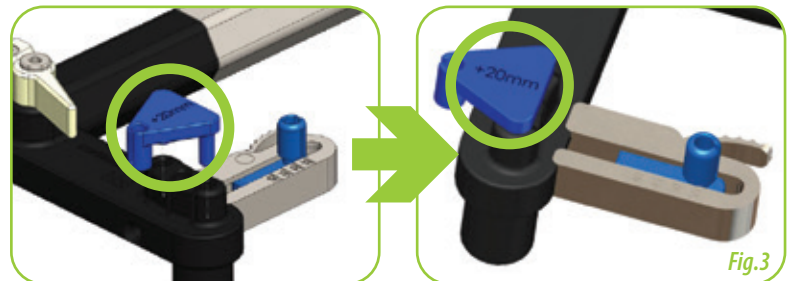

Advised graft's length for PCL		
PATIENT'S HEIGHT M/F (cm)	PATIENT'S HEIGHT M/F (feet & inch)	Cursor's position (in mm) on workstation
H < 165	H < 5'5"	between 55 and 60
165 < H < 174	5'5" < H < 5'9"	between 60 and 65
175 < H < 189	5'9" < H < 6'3"	65
H > 190	H > 6'3"	70

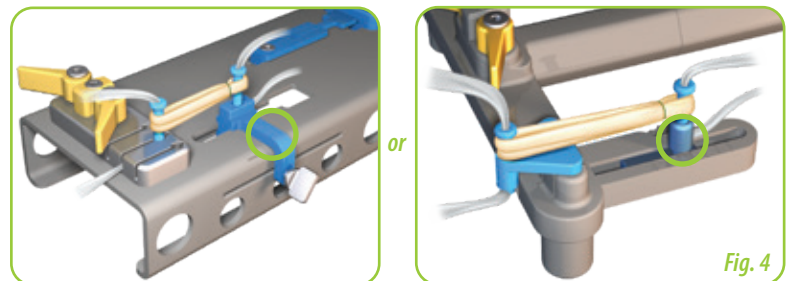

Graft length cursor

Fig. 4



PRECONDITIONING OF THE GRAFT (Fig.5)

While securing the graft in the tensioner, and before placing the graft under tension, make sure the movable tape clamp is snug up against the stop button on the crossbar. Then:

- Secure the tapes in the tensioner clamps
- Turn the screw at the end of the tensioner until it is hand tight and resistance is noted.
- Push the tensioning lever down to a fully seated position and begin recording the time under this amount of tension for 1 minute.

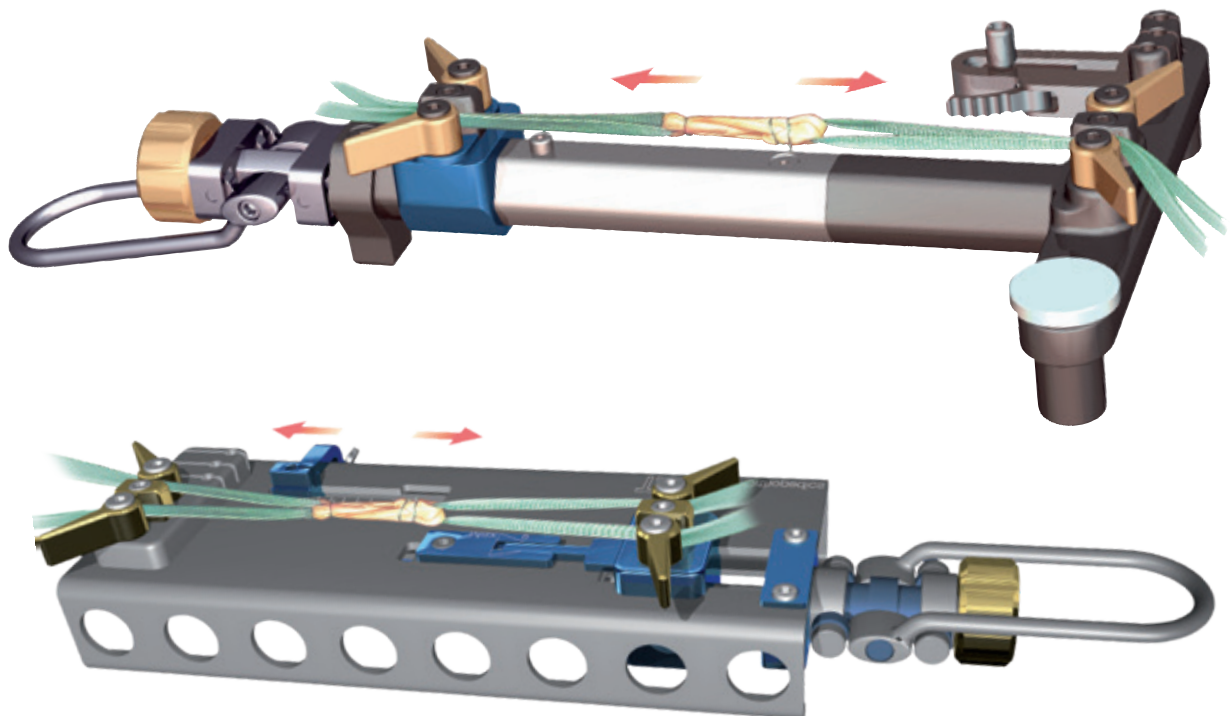

Fig. 5

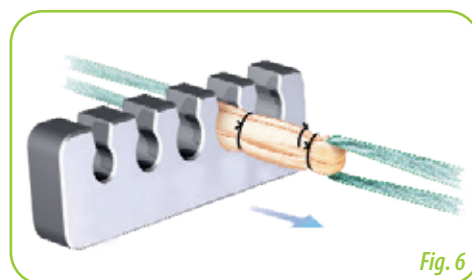

Fig. 6

GRAFT DIAMETER

Determine the graft diameter at each end of the graft by using the graft diameter gauge included in the standard instrument set. Select the retrograde reamers accordingly. (Fig. 6)



ARTHROSCOPIC STEP

Create antero-lateral and antero-medial portals for optic and instrument tracts, close to the patella and as high as possible. Joint preparation is standard, however careful cleaning of the notch is recommended.

A postero medial arthroscopic view can be used.

The universal guide provided with the instrumentation makes possible outside-to-inside targeting for both the tibia and the femur.

OUTSIDE-IN TIBIA TARGETING

With the knee at 90°, move forward all the posterior vascular structures.

Insert only the PCL tibial hook to carefully clean the retro spinal surface by using the tip of the tibial guide hook under X-RAY control and/or an optical postero-medial portal.

Set the PCL guide to 60° in the sagittal plan and 20° in the frontal plane. (Fig. 7)

Notice that a scale engraved on the aimer's sleeve of the guide gives the length of the future tunnel to check sufficient tunnel length. For the tibia it should be at least 45mm otherwise use a 20mm screw (40mm minimum tunnel length). (Fig. 7)

Place the hook on the posterior 1/3 of the retrospinal surface. X-RAY is required. (Fig. 8)

Use the 2.4mm guide pin to target the exact placement of the tunnel.

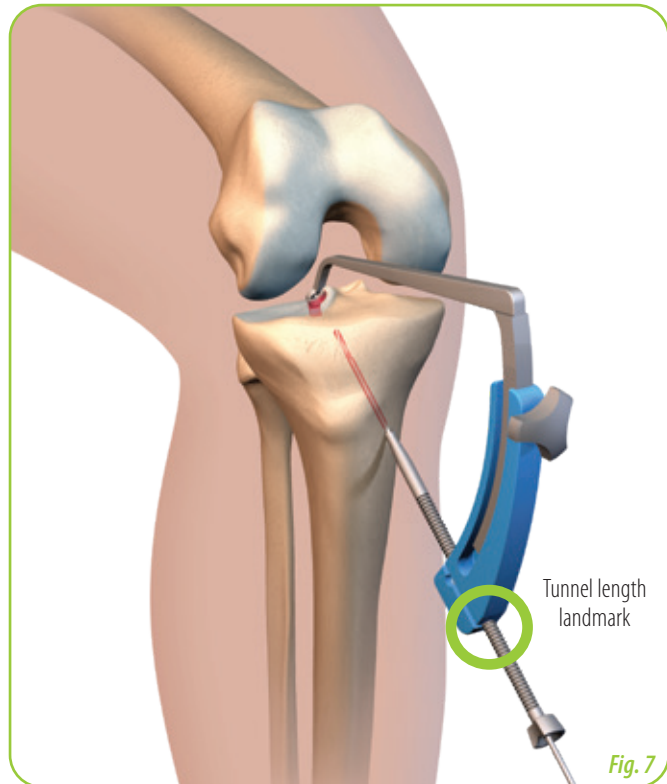

Fig. 7

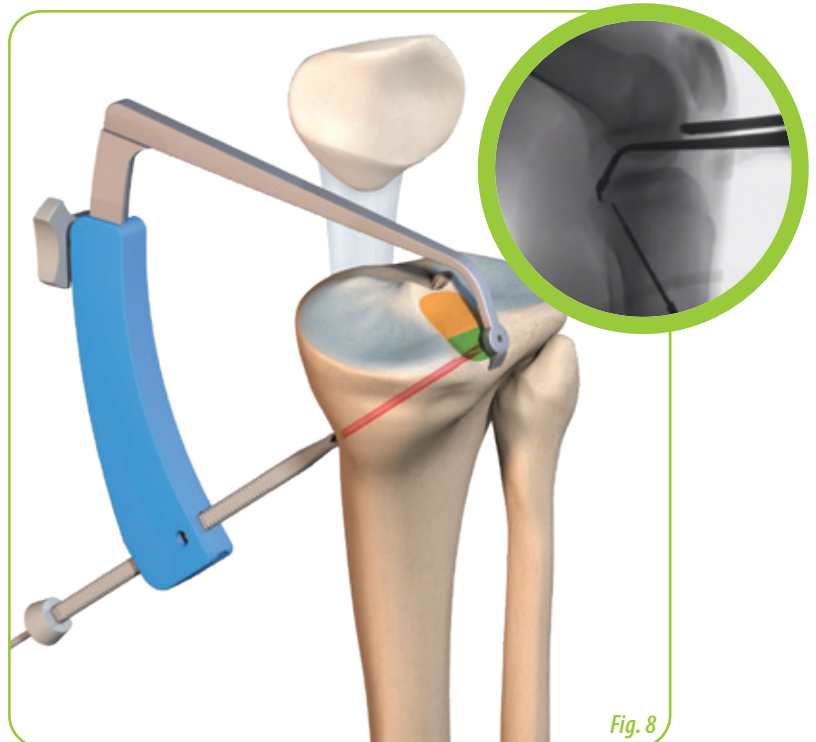
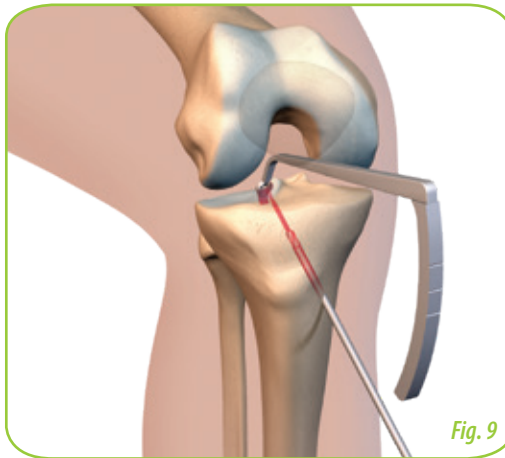

Fig. 8



REAMING THE TIBIA

With the tibial hook as a protection, overdrill the 2.4mm guide pin with a 4.5mm reamer always with both X-RAY control and arthroscopy. (Fig. 9)

Maintain the 4.5mm drill, take out & flip the pin 2.4 guide pin then introduce again the guide pin in the 4.5mm drill to get the atraumatic end of the pin in contact with posterior soft tissues.

Take out the tibial hook and the 4.5mm drill.

Warning for BIO-C screws

1. For strong bones, do not use BIO-C screws, use Titanium or Peek screws.
2. Taping for BIO-C screws must be done along the entire screw meaning 20 or 25mm.
3. BIO-C screws must be perfectly engaged in the screwdriver to completely transmit the torque to the screws.

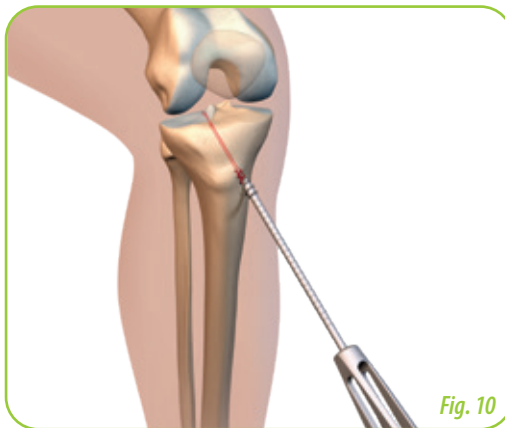

TAPPING THE TIBIA

Use the 2.4mm guide pin to keep alignment accurate.

The entry to the tibia tunnel is tapped on 15 or 20 mm in length according to the screw selected (20 or 25mm length).

Use the graduated marks on the tapping sleeve to control introduction. (Fig. 10)

Do not tap to aggressively.

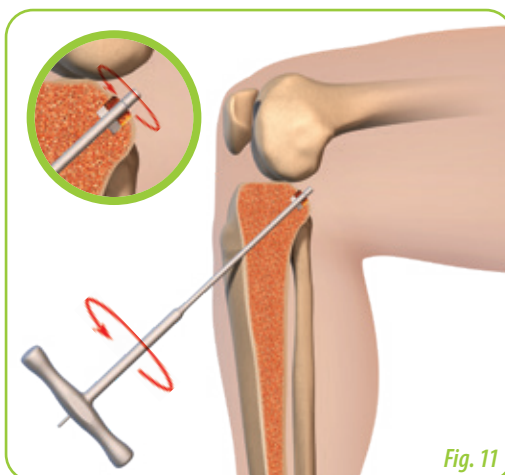

RETROGRADE REAMING OF THE TIBIA SOCKET

The retrograde reamer inserted over the 2.4mm guide pin in the frontal plane. Use X-RAY controls.

The tibial socket is formed to a depth of 15mm which corresponds to bringing the distal end of the reamer shaft to the level of the bony aperture. (Fig. 11)

The retrograde reamer is then removed with the wings in the same position as when it was inserted.

Clean the entrance of the socket by using a tilted vaporization electrode to facilitate the graft penetration.



OUTSIDE-IN FEMUR TARGETING

Use the native PCL fibers to target the placement of the 2.4mm guide pin in the original PCL footprint. (Fig. 12a)

Set the PCL aimer at 110°.

PCL hook must be positioned in the center of the antero lateral footprint.

Intra-articular aperture can be selected and marked with an awl (option in the TLS instrument set) via a medial joint line portal. (Fig. 12b)



This creates a pilote hole.

PCL guide must be 45° in the frontal plan and 20° anterior in the sagittal plan to reach a minimum of 35mm tunnel length. (Fig. 12c)

Notice that a scale engraved on the sleeve of the guide gives the length of the future tunnel to check sufficient tunnel length.

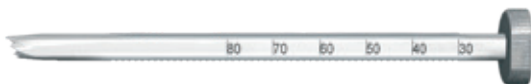

Drill the guide pin then maintain it with a grasper inside the joint.

REAMING THE FEMUR

Guided on the pin overdrill with a 4.5 reamer with arthroscopy control. (Fig. 13)

Take out the 4.5mm drill.



Fig. 12a

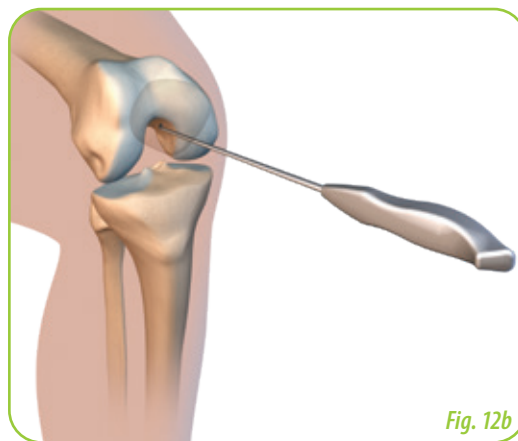

Fig. 12b

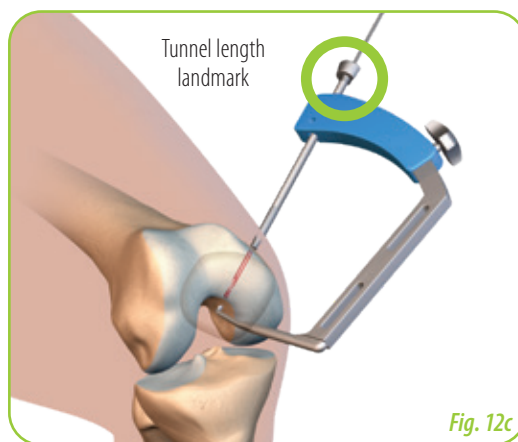

Fig. 12c

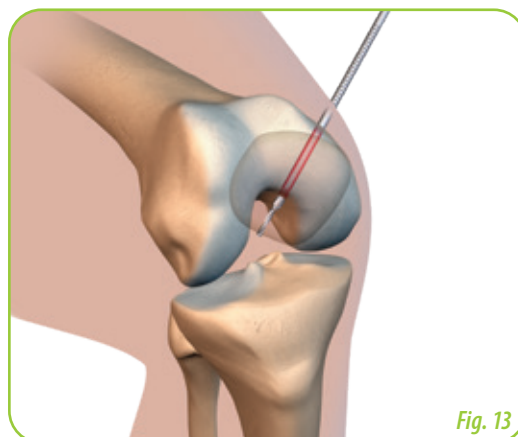

Fig. 13

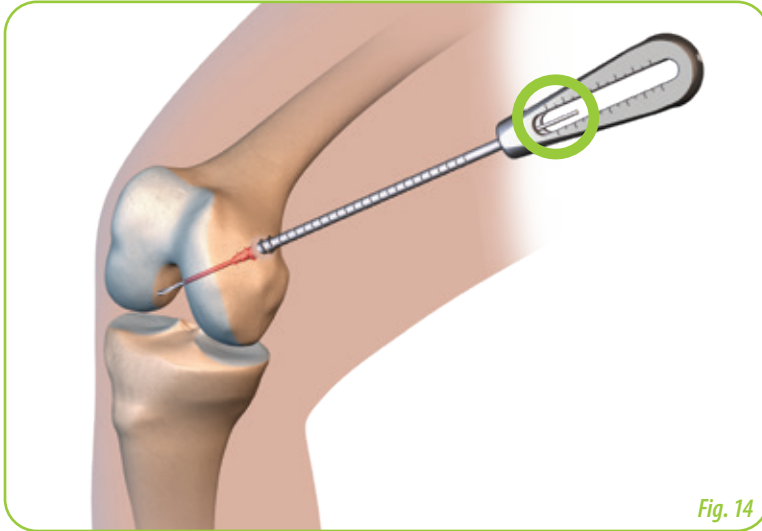

Fig. 14

TAPPING THE FEMUR

Use the guide pin to keep alignment accurate.

The entry to the tibia tunnel is tapped to **5mm ONLY** length according to the screw 20mm because bone is weaker in this area. Use the graduated marks on the tapping sleeve to control introduction. (Fig. 14)

RETROGRADE REAMING OF THE FEMORAL SOCKET

Guided on a pin, the retrograde reamer is inserted in the frontal plan under arthroscopy control.

The femoral socket is formed to a depth of 10mm which corresponds to bringing the laser mark end of the reamer shaft to the level of the bony aperture. (Fig. 15a)

The retrograde reamer is then removed with the wings in the same position as when it was inserted.

Clean the entrance of the socket.

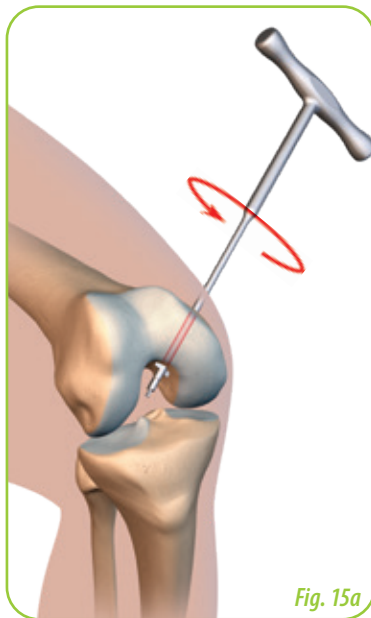

Fig. 15a

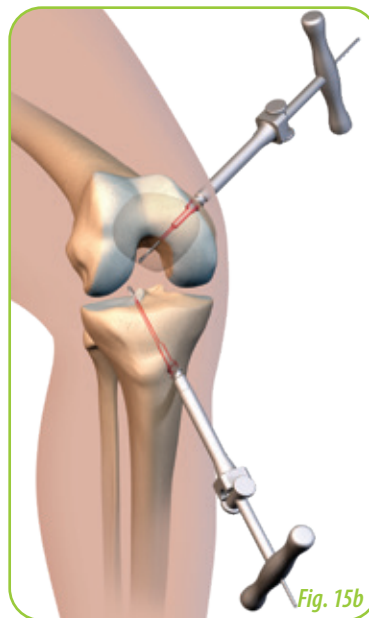

Fig. 15b

CANNULA SET UP

Guided on a pin, the cannula on femur and tibia are inserted into the previously tapped tunnels thanks to a cannula driver. (Fig. 15b)

The pins are then removed.



WARNING: insert the cannula until it is stable but, not more than 15 or 20mm otherwise it will overtap.

If the bone is weak, **DO NOT USE** the CANNULA and use the cannula stop piece only.





CLEAN THE POSTERIOR WALL

The posterior corner should be cleaned by suction with cannula or an opened blade shaver to take out bone debris. (Fig. 16)

PASSING THE THREADS IN THE TIBIA

The medial arthroscopic entrance is widened to insure that the graft will pass through it (very important or the graft will not pass across the skin).

The traction is passed from the outside to the inside through the tibial tunnel using the PCL thread puller and is recovered instrumentally by the antero medial portal using retrieval forceps.

Safeguard the tibial draw suture by securing the loop end to the free ends with a clamp.

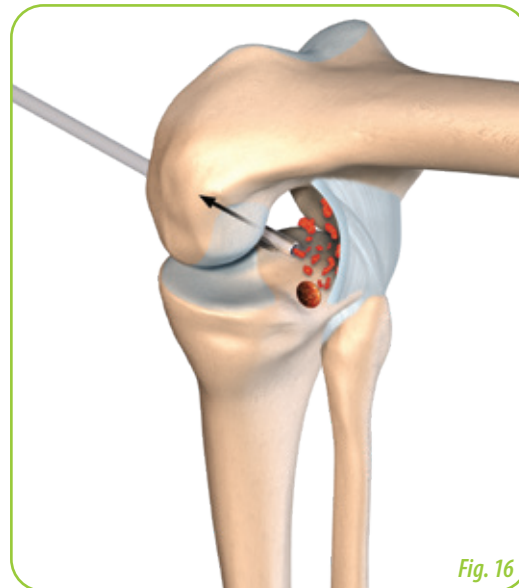
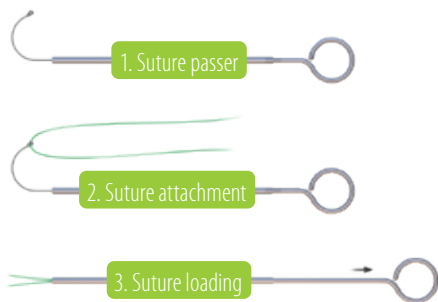

Fig. 16



4. Suture retrieving through the tibia

PASSING THE THREADS IN THE FEMUR

The traction is passed from the outside to the inside through the femoral tunnel using the PCL thread puller and is recovered instrumentally by the antero medial portal using retrieval forceps. (Fig. 17)

It is important that both sutures are retrieved together in the same maneuver to ensure that they pass through the same tissue tunnel. It is also important that the sutures remain separate from each other by taking care that the looped end of one does not pass through the looped end of the other.

Safeguard the femoral draw suture by securing the loop end to the free ends with a clamp.

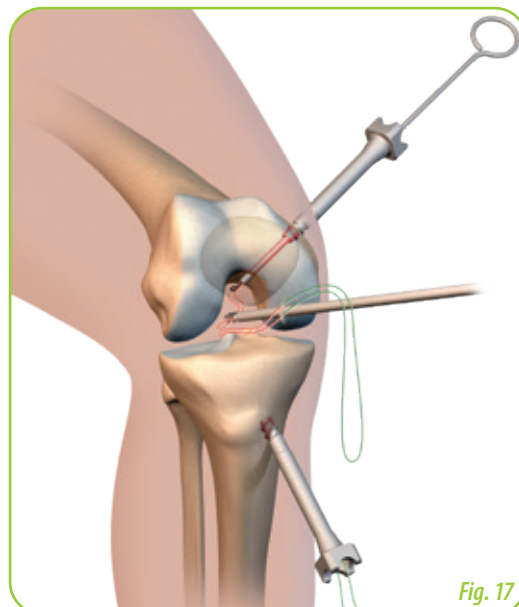
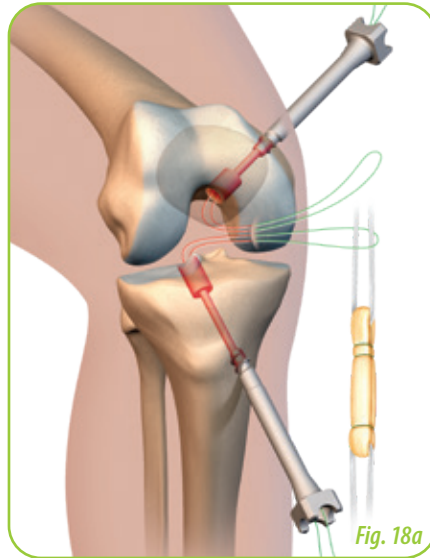

Fig. 17



IMPLANTING THE GRAFT, FIRST BY TIBIA

The graft will be drawn into the joint, and then into the tibial socket with the traction thread looped around the tape of the construct. Be careful to only loop approximately 5cm of the tape to keep it from being too bulky to easily pass. (Fig. 18a)

Pull the traction thread will pull the tape and will automatically position the graft appropriately closed or inside the tibial socket. (Fig. 18b)

Use the same procedure on the femur.

The femur "sardine tin key" maneuver at the tip of the cannula is performed arthroscopically to tract the graft and verify his penetration in the socket: 10mm for the femur & 15mm for the tibia. (Fig. 18c)

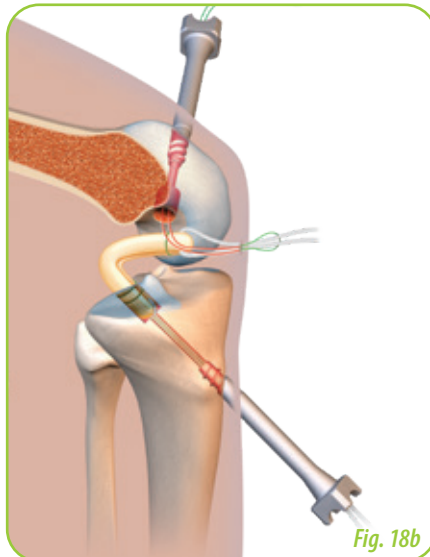

FIXING THE FEMUR: TLS 20MM SCREW

Visually ensure (arthroscopically) that the graft has been drawn into the femoral socket up to the 10mm marking.

The guide pin is positioned in between the two tapes until there is contact between tip of the pin and the implant tendon.

Remove the metal cannula while holding the guide wire sandwiched between the tapes. Separate the tapes and ensure that the wire is positioned between them.

Advance a 20mm length locking screw over the guide wire while strong traction is maintained on the tapes. Advance the screw until it is flushed with the bony cortex, **at least one thread of the screw must be in the cortex.** (Fig. 19)

In case of poor bone quality use a 12mm screw.

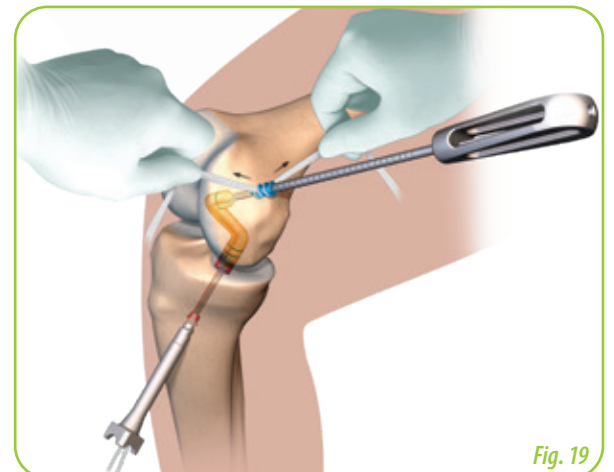
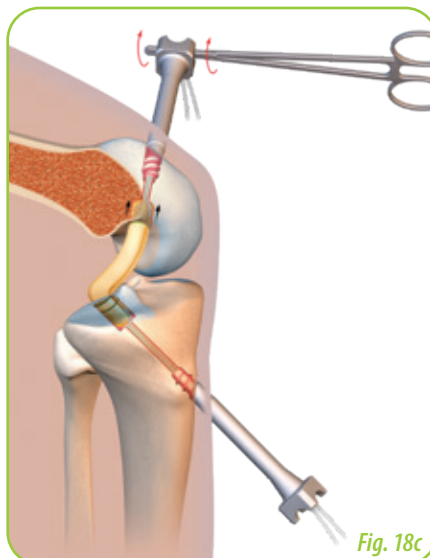



FIXING THE TIBIA: TLS 20 OR 25MM SCREW

Reduce manually the posterior drawer to get the ACL at the native tension, knee at 90°, no rotation and perform on the tibia the “sardine tin key” maneuver. Control arthroscopically to track the PCL graft into its 15mm tibial socket to get a press fit effect. (Fig. 20a)

Control the range of motion while maintaining manually the posterior drawer reduction to get the ACL in tension.

Tract again the PCL graft, if necessary, to get the native tension of a PCL.

With the knee at 45°, a guide pin is positioned in between the two tapes until there is contact between tip of the pin and the transplant.

DO NOT PUSH THE GRAFT !

Remove the metal cannula while holding the guide wire sandwiched between the tapes. Separate the tapes and ensure that the wire is positioned between them.

Advance the 25mm length screw (or 20mm if the tunnel is not long enough) over the guide wire while strong traction is maintained on the tapes. (Fig. 20b)

Advance the screw until it is flush with the bony cortex. At least one thread of the screw must be in the cortex.

In case of poor bone quality use a 12mm screw.

Visualize and probe the graft arthroscopically after fixation has been completed. Check the isometry and that the posterior drawer disappeared.

Cut away excess tapes with the tape cutter on the femoral side then tibial side. (Fig. 20c)

POST OPERATIVE X RAYS

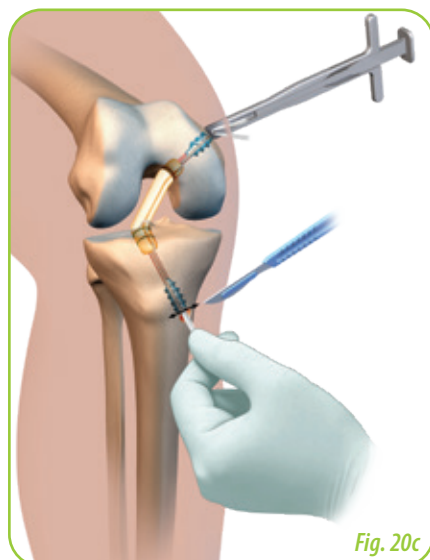
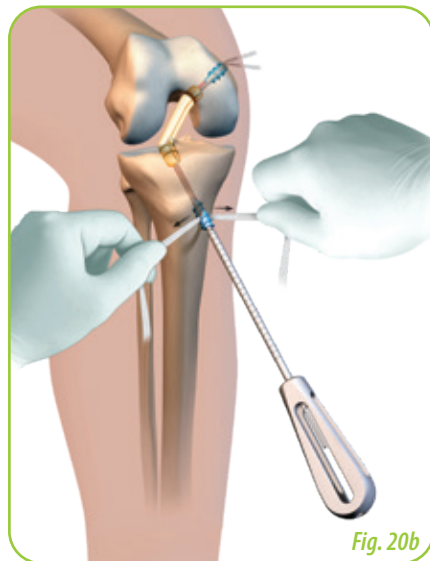
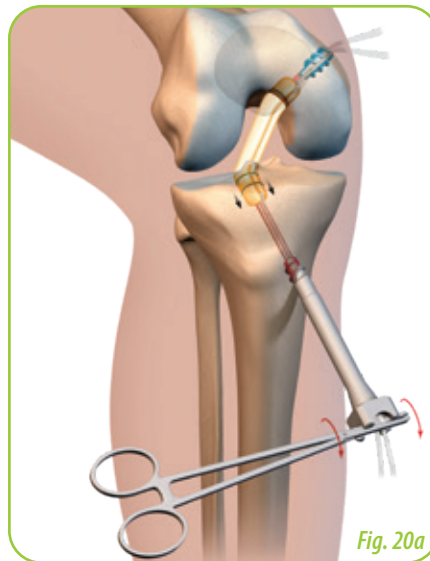
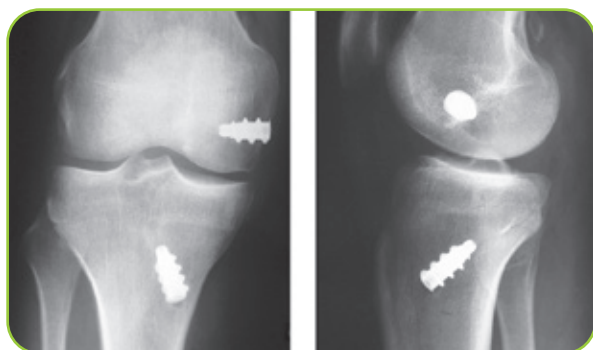

POST OP REHAB - SUGGESTION

From 1st to 21st day:

- Maintain a full extension with brace, practice against the flexum, obtain 100° of flexion
- Locking in full extension against the gravity, wake up of the quadriceps
- Full weight bearing
- Rehab in decubitus ventral

From 21st to 30th day:

- Walk without brace
- Hamstring wake up & isometric work of the quadriceps against proximal resistance.

From 30th to 60th day:

- Get complete mobility.

From 120th day:

- Start of Intensive Muscular reinforcement
- Proprioceptive rehab.

TLS[®] INSTRUMENT SET

ref.

For a PCL surgery, the TLS ACL instrument set ref. 265 645 or 265 644 is required as well as the PCL complementary instrument set ref. 266 149 which is composed of:

PCL TRAY		266 843
PCL TRAY LID		266 844
PCL TIBIAL GUIDE V5		264 928
PCL FEMORAL GUIDE V5		264 929
UNIVERSAL GUIDE HANDLE V5		264 930
PCL SUTURE PASSER		264 931
UNIVERSAL GUIDE DRILLING SLEEVE V5		264 939
PCL PREPARATION TABLE EXTENSION		266 853
OPTION	TLS [®] SCREWDRIVER FOR BIO-C SCREW	264 650
	PIN FOR TLS [®] BIO-C SCREW Ø 1,2	264 651
	ANGULATED AWL	265 641
	HARVESTING HOOK	265 642
	CANNULA STOP PIECE	266 314
	INLINE MASS FOR PEEK SCREWDRIVER	266 864
	RETROGRADE REAMER (SHORT TIP) Ø 9	257 047
	RETROGRADE REAMER (SHORT TIP) Ø 10	257 048



PCL instrument set



Retrograde reamer (short tip)

TLS[®] IMPLANTS

ref.

TLS [®] TENDINOUS FIXATION SCREW Ø 10MM LG 20MM	253 569
TLS [®] TENDINOUS FIXATION SCREW Ø 10MM LG 25MM	248 853
TLS [®] TENDON ANCHORING SCREW Ø 12MM LG 20MM	264 274
TLS [®] TENDON ANCHORING SCREW PEEK Ø 10 MM LG 20 MM	263 653
TLS [®] TENDON ANCHORING SCREW PEEK Ø 10 MM LG 25 MM	263 654
TLS [®] TENDON ANCHORING SCREW BIO-C (70% PLLA - 30% B TCP) Ø 10MM LG 20MM	264 648
TLS [®] TENDON ANCHORING SCREW BIO-C (70% PLLA - 30% B TCP) Ø 10MM LG 25MM	264 649
TLS [®] TENDON ANCHORING TAPE (x2) (blade + shuttle wires included)	265 746
TLS [®] TENDON ANCHORING TAPE (x1) -OPTION	256 193



TLS[®] anchorage tape



TLS[®] Titanium screw



TLS[®] Peek screw



TLS[®] BIO-C screw



DISTRIBUTEURS
DISTRIBUTORS

GRUPE
FH ORTHO[™]

FR, FH ORTHO SAS
3 rue de la Forêt - Zone Industrielle
BP 50009
68990 Heimsbrunn CEDEX - FRANCE
Tél. +33 (0)3 89 81 90 92
Fax: +33 (0)3 89 81 80 11
info@fortho.com
www.fortho.com

USA, FH ORTHOPEDICS INC.
OrthoEx
7327 E Tierra Buena Lane
Scottsdale, Arizona 85260 - USA
Phone: +1 (412) 965-0950
customerservice@fortho-us.com
www.fortho.com

PL, FH ORTHO POLSKA
Ul. Garbary 95/A6,
61-757 Poznan - POLSKA
Phone: +48 61 863 81 27
Fax: +48 61 863 81 28
biuro@implants24.pl
www.fortho.com



FABRICANT
MANUFACTURER

FR, FH INDUSTRIE
6 rue Nobel, Z.I. de Kernevez
29000 QUIMPER - FRANCE
Tél. +33 (0)2 98 55 68 95
Fax: +33 (0)2 98 53 42 13
contact-fhi@fortho.com
www.fortho.com